

SEKONIC

SEKONIC

OPTICAL
MARK READER
SR-3500/SR-6500

OPTICAL
MARK READER **SR-3500**
SR-6500

Operating manual

Operating Manual

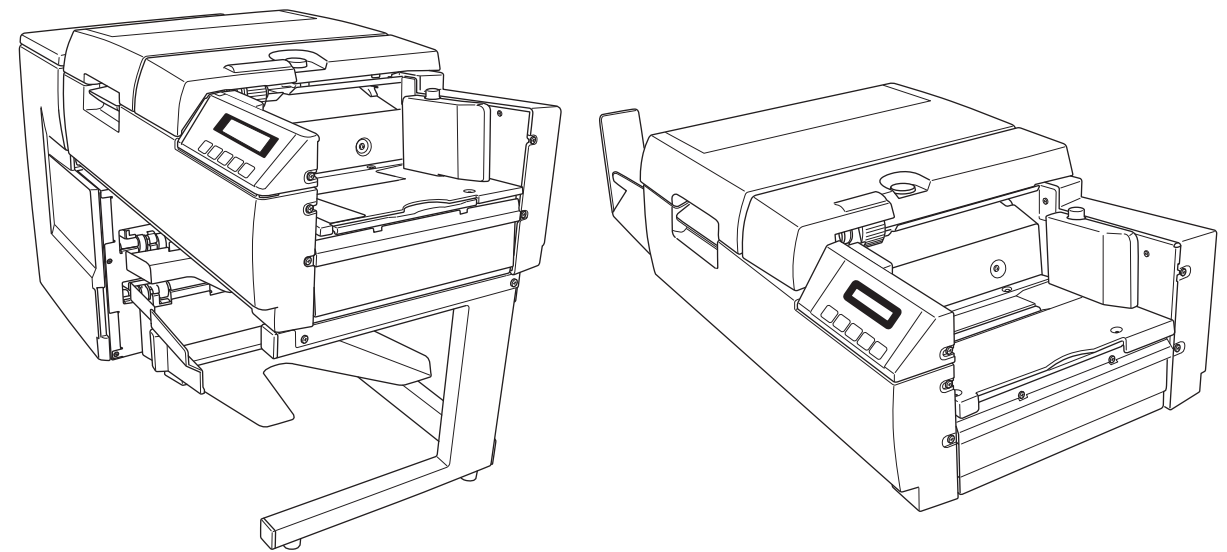

SEKONIC CORPORATION

7-24-14, Oizumi Gakuen-cho, Nerima-ku, Tokyo 178-8686, Japan
Telephone: +81-3-3978-2375 Facsimile: +81-3-3978-5229

CC0797100

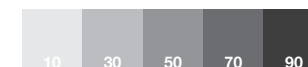

Introduction

Thank you very much for purchasing our product.
Please read the operating manual before using this product, and be sure to use it properly.
After reading this operating manual, be sure to keep it in a place that you can access at any time.

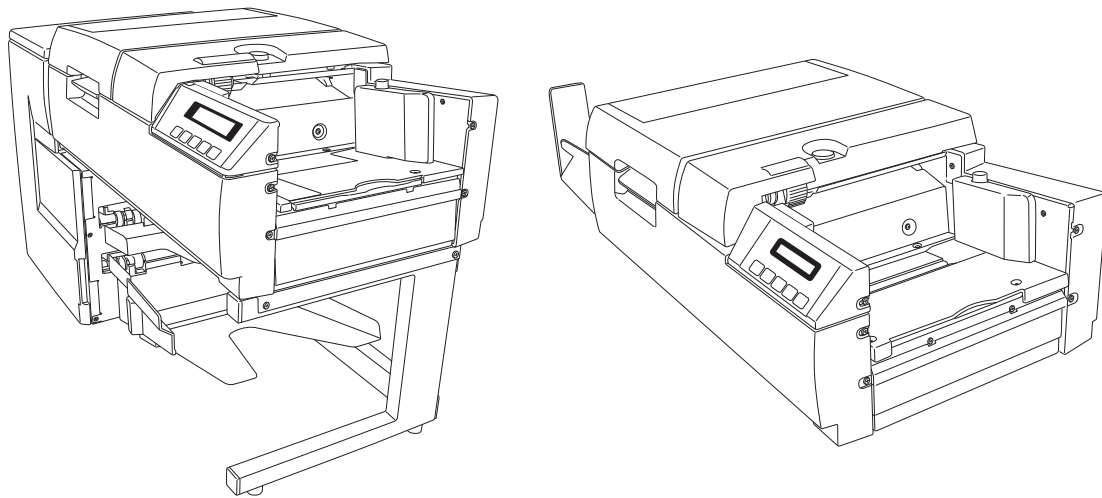

This equipment has been tested and found to comply with the limits for a Class B digital device, pursuant to Part 15 of the FCC Rules. These limits are designed to provide reasonable protection against harmful interference in a residential installation. This equipment generates, uses and can radiate radio frequency energy and, if not installed and used in accordance with the instructions, may cause harmful interference to radio communications. However, there is no guarantee that interference will not occur in a particular installation. If this equipment does cause harmful interference to radio or television reception, which can be determined by turning the equipment off and on, the user is encouraged to try to correct the interference by one or more of the following measures:

- Reorient or relocate the receiving antenna.
- Increase the separation between the equipment and receiver.
- Connect the equipment into an outlet on a circuit different from that to which the receiver is connected.
- Consult the dealer or an experienced radio/TV technician for help.

Table of contents

Safety precautions	5
Before using	8
Power cord list for Europe	11
Warranty	12
Precautions for use	13
Names of parts	16
■ Operating panel functions and operating instructions	18
Product specifications	19
Operation	
■ Preparation	21
■ Turning power on	25
■ Loading paper	26
■ Setting paper weight	28
Marking instructions	29
Connecting to a computer	30
■ USB	
1. Operating mode	31
2. Interface settings	32
■ RS-232C	
1. Operating mode	33
2. Interface settings	
2-1. Setting baud rate	34
2-2. Setting character bit length	34
2-3. Setting parity	35
2-4. Setting stop bit	36
2-5. Setting flow control	36
2-6. Setting character code	37
Data reading settings	
■ Setting column	38
■ Setting reading method	39
■ Setting min. density level	41
■ Setting density balance	42
■ Setting reading side	43
■ Setting hopper mode	44
■ Setting paper weight	46
■ Setting paper hold(SR-3500)	47
Error detection settings	48
Buzzer settings	
■ Buzzer control	50
■ Buzzer sound adjustment	51

Stacker settings	52
Printer settings	
■ Printer control	53
■ SR-2300 SR-6500 mode	
1. Character size setting	54
2. Character interval setting	55
■ SR-600 SR-9000 mode	
1. Character size setting	57
2. Character magnification setting	58
3. Character interval setting	59
Barcode settings	
■ Barcode control	61
Low power consumption settings	
■ Sleep duration	62
■ Standby duration	63
Displaying various information	
■ Displaying the version	64
■ Displaying front side reading sensor settings	65
■ Displaying back side reading sensor settings	66
■ Displaying optional unit settings	67
■ Displaying total count	68
■ Displaying serial number	69
Operating tests	
■ Feed test 1	70
■ Feed test 2	71
■ Printer test	72
■ Printer jet test	73
Options	
Stacker unit	
■ Stacker unit specifications	74
■ Stacker unit (printer) preparation	75
■ Printing position adjustment	78
■ Clearing paper jams	81
■ Stacker unit precautions for use	82
Back side reading unit	83
Printer unit	
■ Printer unit specifications	84
■ Printer unit preparation	86
■ Printable area	86
■ Printing position adjustment	87
■ Printer unit precautions for use	89
Barcode unit / V • Barcode unit / H	
■ Barcode unit specifications	90

■ Barcode readable area	92
■ Barcode reading position adjustment	94
■ Barcode unit precautions for use	96
Cleaning	97
■ Cleaning procedures	99
Service schedule	102
External diagram	104
List of menu modes	106
Error displays and countermeasures	
1. Errors.....	109
2. Warnings	113
OMR glossary	116

Appendix ■ Sheet creation reference

Safety Precautions

These “Safety Precautions” pages list various symbols for ensuring safe operation of this product so as to prevent users or other people from being injured, or property from being damaged.





Read these precautions thoroughly and understand the meanings of the symbols before proceeding to the main text of this manual.

Warning

Improper operation by neglecting these instructions may result in death or serious injury.

Caution

Improper operation by neglecting these instructions may result in personal injury or property damage.

	Neglecting these instructions may generate smoke or fire.
	Neglecting these instructions may cause electric shock.
	Indicates a prohibited action.
	Indicates that disassembly or modification is prohibited.
	Indicates that the power plug must be removed from the outlet for safe operation.

Warning

 **Warning**

- Fire or electric shock may result if this product continues to be used when there is a strange smell or sound. In such a case, immediately turn the power switch off and then remove the power plug from the outlet. After making sure that it is no longer smoking, ask the sales shop for repair service. Never attempt to repair by yourself since that may be very dangerous.



- Do not modify or disassemble this device. That could cause fire or electric shock.
- Do not remove the cover from this device. That could cause electric shock. Ask the sales shop to conduct any internal checking, adjustment or repair. Pay thorough attention to the above instructions. Otherwise, fire or electric shock may occur.



- Power plug precautions
 - Do not pull on the cord when removing the power plug from the outlet.
 - Do not use any power plug other than the specified one. Make sure to use the adapter included in the package.
- Device precautions
 - Do not use it with a supply voltage other than the specified one.
 - Do not install it in a place that may be wet with water or oil, steam, moisture or dust.
 - Do not insert or drop any metal, foreign combustible matter, etc., into the port.
 - Do not place containers with chemicals or water, or small metal pieces near the device.



- Do not cover the vent hole. That could cause heat retention, resulting in fire.



- If the device is dropped or the cover is broken, immediately turn the power switch off and remove the power plug from the outlet. Then, contact the sales shop.



- If any foreign matter should enter inside, immediately turn the power switch off and remove the power plug from the outlet. Then, contact the sales shop or Sekonic. If the device continues to be used with foreign matter inside, fire or electric shock may occur. If water or other substances penetrate the unit, immediately turn the power switch off and remove the power plug from the outlet. Then, contact the sales shop or Sekonic. If the device continues to be used with water or other foreign matter inside, fire or electric shock may occur.





Caution

- Do not place the device in an unstable location. Otherwise, it may fall or collapse, resulting in injury.



- When opening or closing the upper part of the main body, do not place your hand on the paper-feeding surface. Otherwise, fingers may be caught, resulting in injury.
- If you must touch the paper-feeding surface of the main body, be careful not to allow your fingers to be caught or hit.



- When doing maintenance on the device, for your own safety, be sure to remove the power plug from the outlet.
- When the device is not in use for long periods, for safety, remove the power plug from the outlet.



- Before moving the device, be sure to remove the power plug from the outlet. If the cable is damaged, fire or electric shock may occur.



- Do not connect or disconnect the power plug if your hands are wet. Otherwise, an electric shock may occur.



- Do not put heavy things on the device. Otherwise, it may fall or collapse, resulting in injury.



Before using(SR-3500)

Before using the device, check if all of the following items are included in the package. If components are missing or damaged, contact the store where you purchased the device.

1. Main body unit

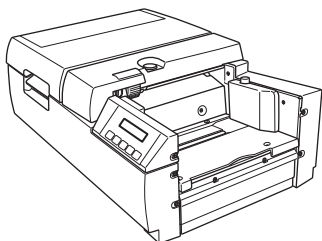

2. Paper receiver

(Not used when the select stacker unit is installed.)

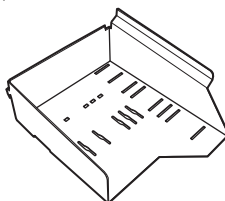

3. Paper discharge brackets

(x 2: Not used when the select stacker unit is installed.)

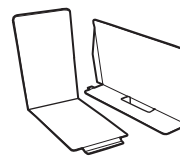

4. Paper feeding bracket



5. Power cord
For U.S.A

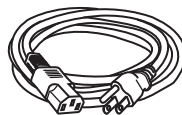

For Europe

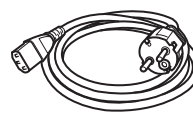

Note)
Refer to the power cord list for Europe of next page.

6. Operating manual
(this booklet)



7. A4 check sheets (5 sheets)
A4 mark entry sheets (5 sheets)



Mark entry sheet:
use it as an example when designing entry sheets.

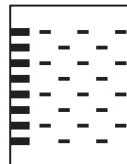

Check sheet:
use it for checking OMR operations.

8. CD-ROM

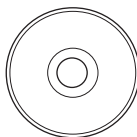

9. USB cable



Note)
The package doesn't include a RS-232C(9 pins) interface cable. You may need to get one depending on your computer port or connection method.

Stacker unit (Option)

* See the installation manual for components to be used for installation.

1. Stacker

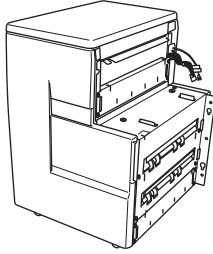

2. Main tray

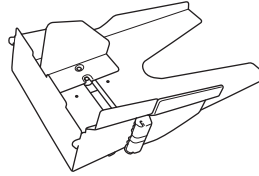

3. Selection tray

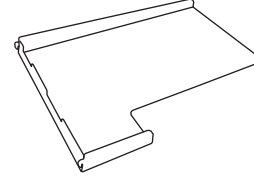

Printer unit (Option)

1. Ink cartridge

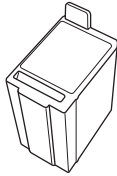

2. Storage bag

(Transparent plastic bag)

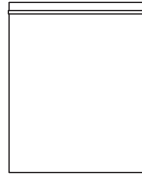

Before using(SR-6500)

Before using the device, check if all of the following items are included in the package. If components are missing or damaged, contact the store where you purchased the device.

1. Main body unit

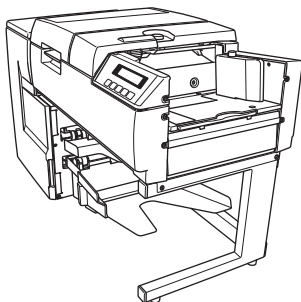

2. Main tray

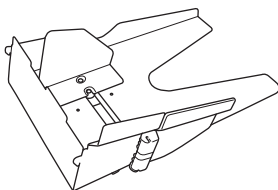

3. Selection tray

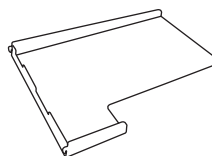

4. Paper feeding bracket



5. Power cord
For U.S.A



For Europe



6. Operating manual
(this booklet)



Note)
Refer to the power cord list
for Europe of next page.

7. A4 check sheets (5 sheets)
A4 mark entry sheets (5 sheets)

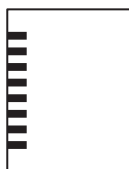

Mark entry sheet:
use it as an example when
designing entry sheets.

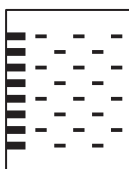

Check sheet:
use it for checking OMR operations.

8. CD-ROM

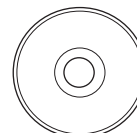

9. USB cable



10. Ink cartridge

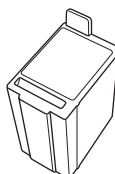

11. Storage bag
(Transparent plastic bag)

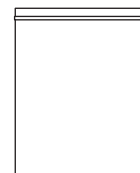

Note)
The package doesn't include a RS-232C(9 pins) interface
cable. You may need to get one depending on your computer
port or connection method.

Power cord list for Europe

As stated on page 7 of this manual, the machine includes a representative variety of power adapters. If none of the included adapters match the power outlets in your location, please find and use an appropriate adapter.

A type
(American Type)

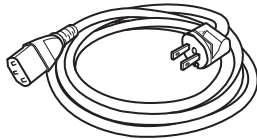

BF type
(British Type)

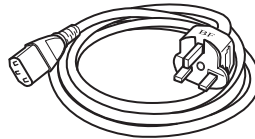

C type
(CEE Type)

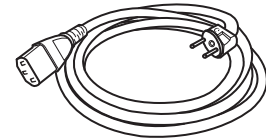

B type
(British Type)

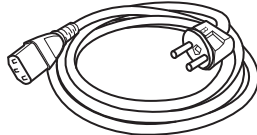

B3 type
(British Type)

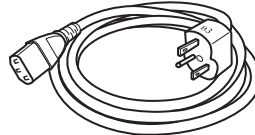

SE type
(CEE Type)

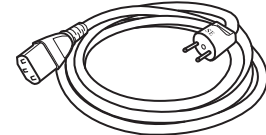

O type
(Ocean Type)

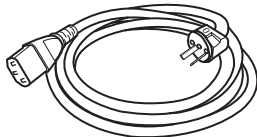

Country	Plug type
U.K.	B, B3, BF, C
Italy	A, C, SE
Austria	B3, BF, C, O, SE
Netherlands	B, C, SE
Greece	B, B3, C, SE
Sweden	B, C, SE
Spain	A, C, SE
Denmark	C
Germany	A, C, SE
Finland	A, B, C, SE
France	A, C, O, SE
Belgium	A, B, C, SE
Portugal	B, B3, BF, C, SE
Luxemburg	A, C, SE
Ireland	A, B, B3, BF, C, SE

Warranty

The cost-free warranty period for this product extends for one year after delivery. The company will repair malfunctions arising during this period free of charge if they are determined to be the company's responsibility. In the event repairs are necessary, as a general rule the company will keep the product temporarily to carry out such repair work.

Malfunctions and other failures caused by customer misuse or by wastage of the parts due to mass processing will not be covered by the warranty.

This warranty covers only this product and its accessories, and the company will not assume any responsibility for monetary damage, lost earnings, or any third-party claims as a result of using this equipment.

Precautions For Use

Handle the device with the following points in mind to enable full use of its functions.

• Precautions regarding installation

Do not place the device in the following places. Otherwise, failures could result such as paper jams, reading errors, or the unit could become inoperative.

- (1) In direct sunlight or near a heating device.
- (2) Outdoors where the main body may not perform satisfactorily due to rain or strong wind.
- (3) A place where the main body may not perform satisfactorily such as it is subject to vibration while operating, or it is placed in an unstable location.
- (4) Places subject to sudden temperature changes, excessive moisture and dust.

Recommended temperature: 10-30°C

Guaranteed operating temperature range: 5-35°C



Humidity: 30-80% (no condensation)

Avoid environments outside the above ranges as much as possible when placing the device.

• Handling precautions

- (1) Do not connect or disconnect the power cord or connector when the device is operating or the power switch is on.
- (2) Do not move the device while it is operating. Also, do not touch, pull, or push paper.
- (3) Do not put objects on the device, or sit or lean on it.
- (4) This device is designed to deferred type. Do not give it a strong vibration and shock etc.
- (5) Allow an interval of at least 5 seconds between turning the power switch on and off.
- (6) Do not insert foreign objects other than paper.
- (7) Do not apply force that deforms paper while it is being loaded.
- (8) Since the paper reading part is equipped with an optical lens, never insert a screwdriver or other such objects. (Otherwise, reading may be disabled.) If paper feeding is disabled due to dust or the like in the paper feeder, open the top cover to remove it. (**See** "Cleaning" P.97)
- (9) If the roller becomes soiled with powder from paper or pencil lead, the roller and the paper may slip. In order to prevent slippage, clean the roller at proper intervals. (**See** "Cleaning" P.97)
- (10) If the exterior of the device is soiled, lightly wipe with a soft cloth wetted with water or a neutral detergent. Note that wiping with a cloth wetted with volatile chemicals like benzene or paint thinner may cause deformation or discoloring.

Handling precautions (continued)

- (11)  Do not apply strong loads to the tray, as it may bend or break.
- (12)  Because the aligning roller section has used the magnet, do not bring close a floppy disk and a magnetic card etc.. It becomes cause of data damage.
- (13)  When moving the device, always hold it under the spots indicated by the green labels.
(Never place your hands in the areas indicated in the circles.)

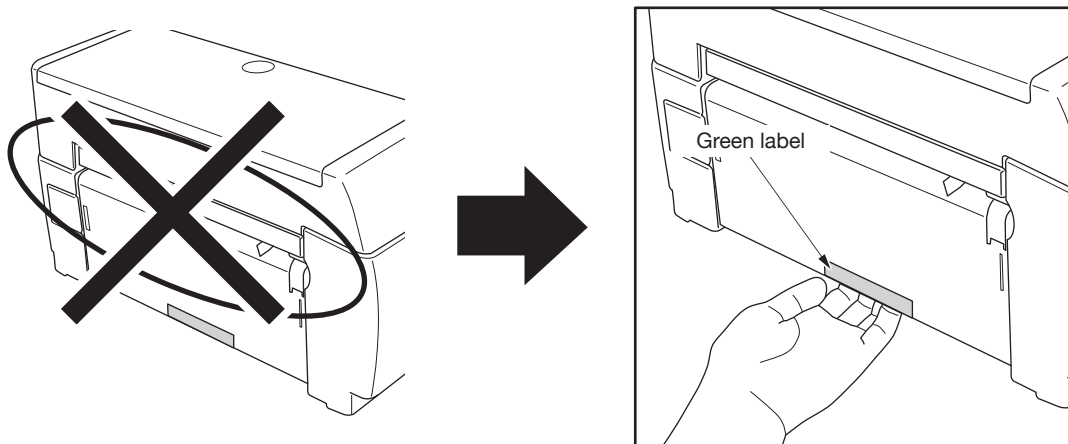
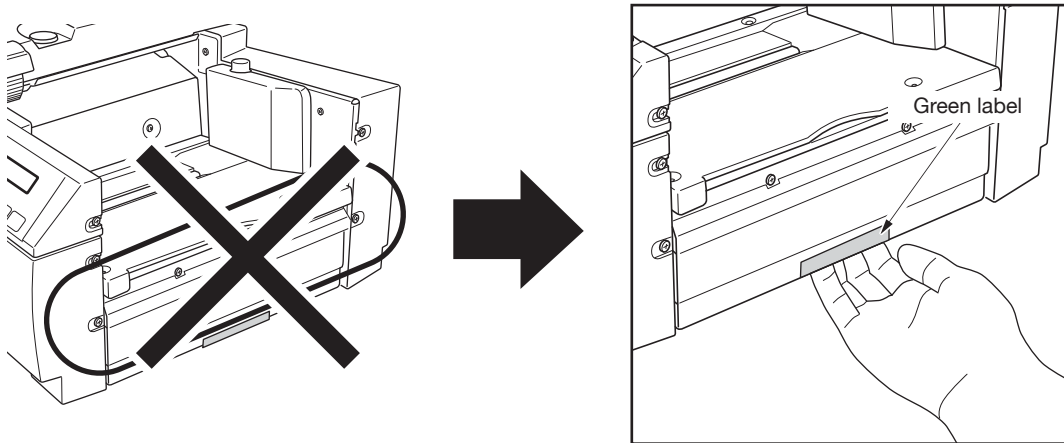

- (14)  Make sure to observe the following points when you handle the device and USB cables. Otherwise, mechanical failure or damage may be caused.
- * Do not forcibly pull or bend the USB cable.
 - * Always hold the plug when you insert or pull out the USB cable. Never apply excessive force to the cable.
 - * When installing/moving the device or a PC, do not apply excessive power to the cord or plug of the USB cable.

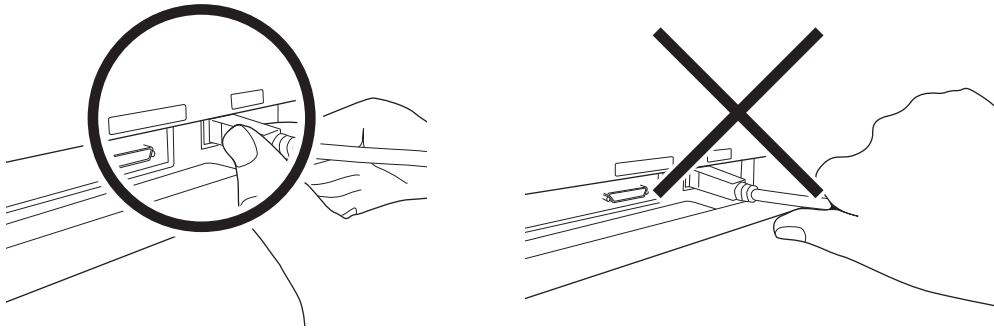

Names of parts(SR-3500)

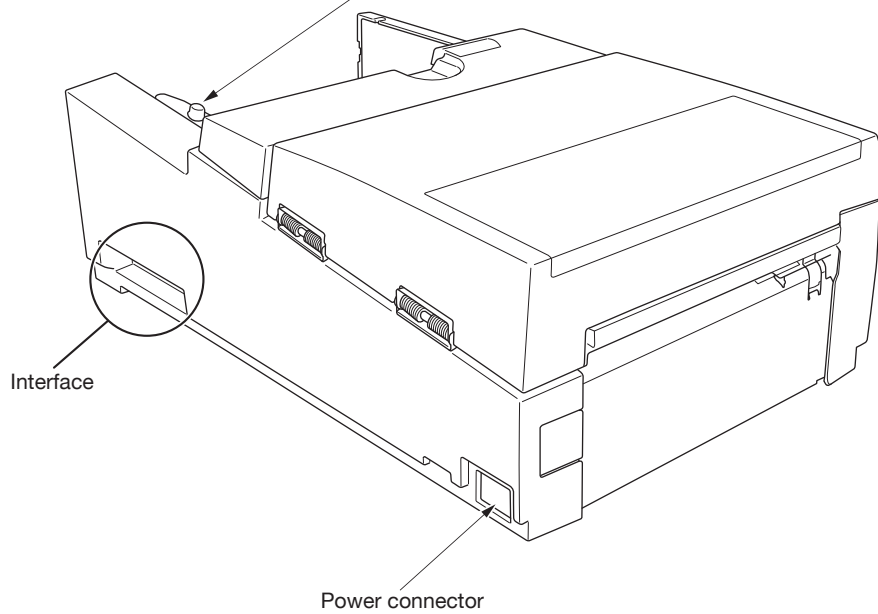
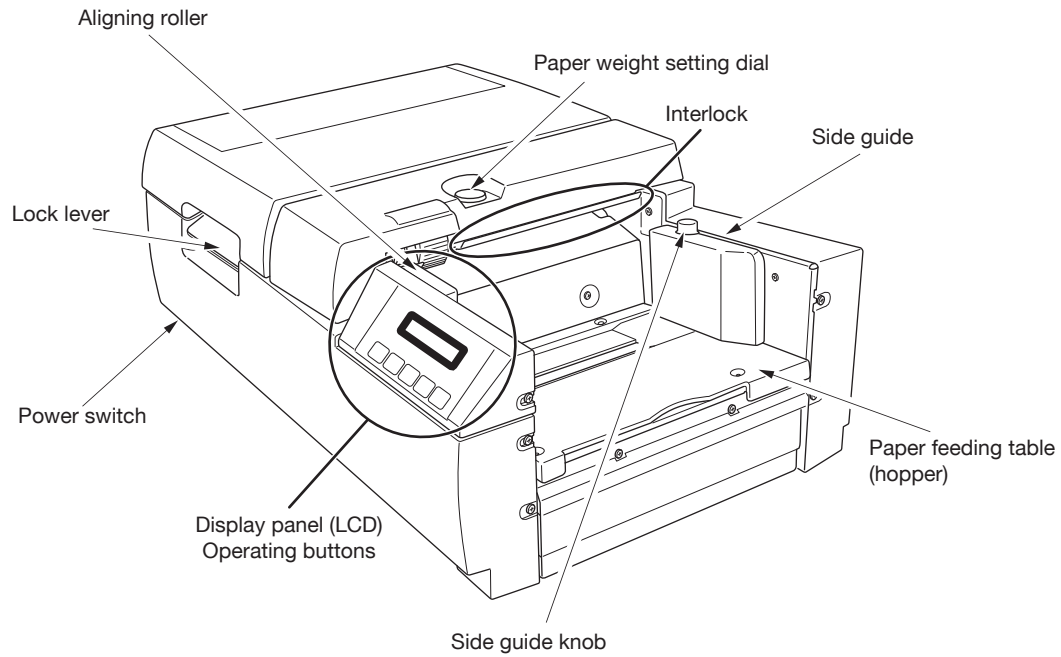

Names of parts (When stacker unit is installed)

※ SR-6500 is equipped with the stacker unit standardly

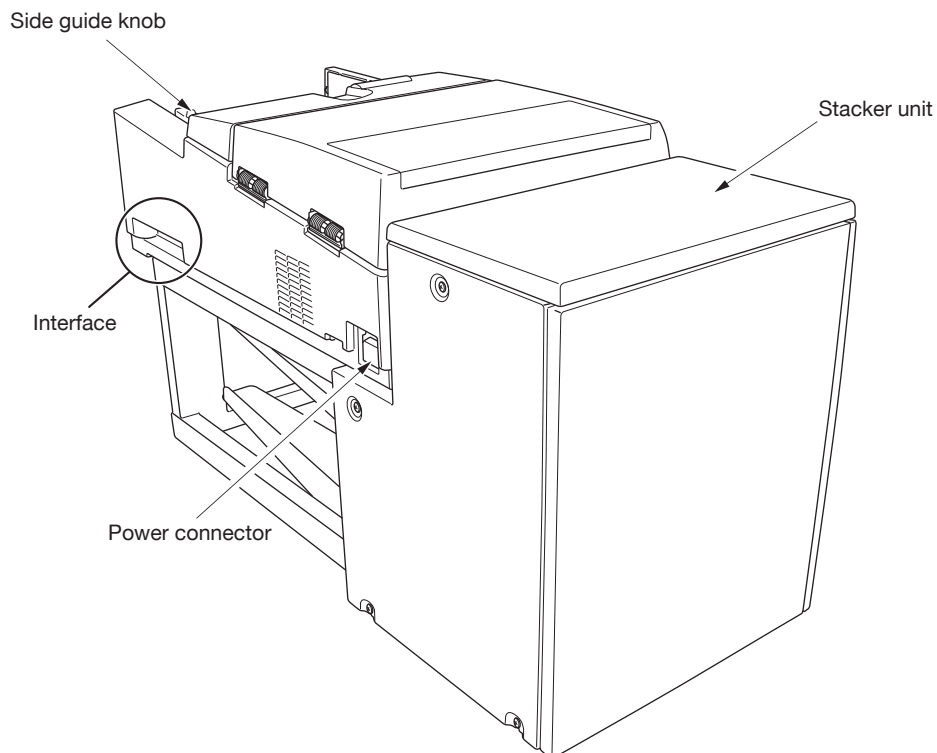
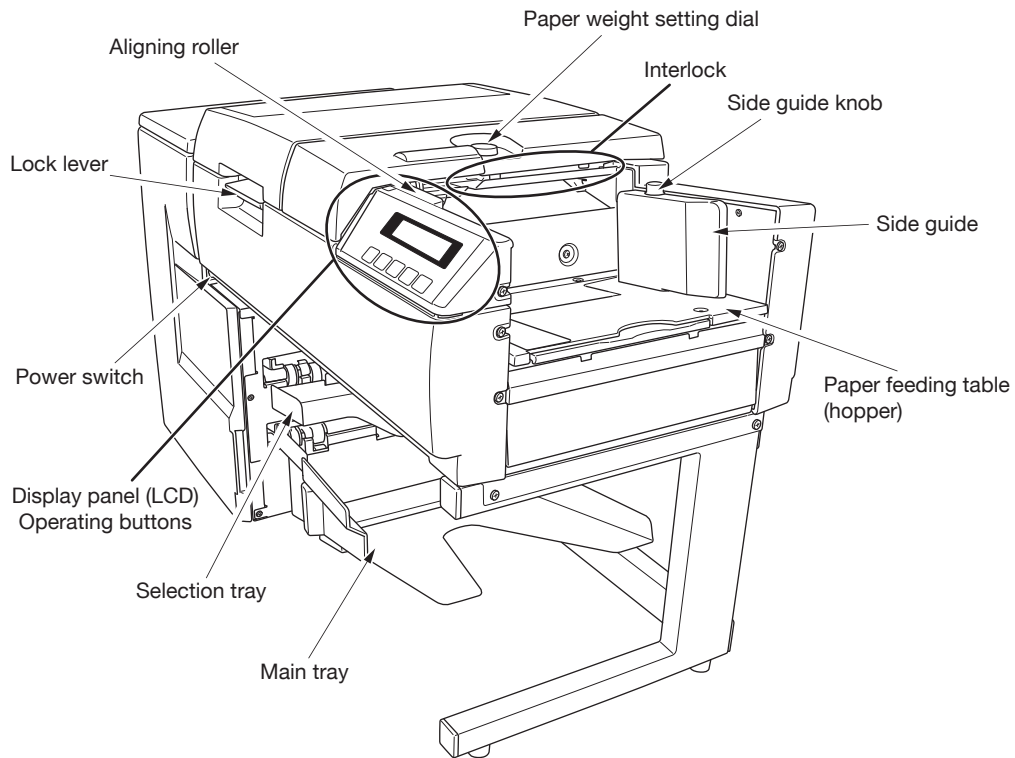

■ Operating panel functions and operating instructions

The operating panel has five kinds of switches.





The switches don't work while the machine is performing a function.



There are two modes: normal mode and menu mode.

In normal mode, the machine is connected to a computer and is controlled by commands from the host.

In menu mode, various settings are controlled by using panel switches.

1.  **switch**
 - (1) Normal mode: Raises the paper-feeding table.
 - (2) Menu mode: Use it to choose menu items and to select parameters. When you push for a long time, while having pushed, it keeps increasing menu items and parameters.
2.  **switch**
 - (1) Normal mode: Drops the paper-feeding table.
 - (2) Menu mode: Use it to choose menu items and to select parameters. When you push for a long time, while having pushed, it keeps increasing menu items and parameters.
3.  **switch**
 - (1) Normal mode: Enters menu mode.
 - (2) Menu mode: Returns to normal mode. (If there is an error, it displays the error.)
4.  **switch**
 - (1) Normal mode: If an error is displayed, you can clear the error. You can also cancel the insertion waiting time if the paper-feeding mode is set for manual paper feeding. Clears the feed count.
 - (2) Menu mode: If an error is displayed, you can clear the error. Moves one level higher in the hierarchy from the current level.
5.  **switch**
 - (1) Normal mode: Feeds one sheet. If you keep the switch depressed, paper is fed as long as the switch is depressed.
 - (2) Menu mode: Executes the selected menu item.

Product specifications(SR-3500)

	Sensor	Reading	Single sided, [double-sided] (* You need an optional back-surface reading unit for double-sided reading.)
		Darkness levels	16 levels (internal 256 levels)
		Light source color	infra red light (940nm) [visible red light (660nm)]
		Pitch (inch)	1/6", 0.2", 0.25", 0.3"
		Marking	infra red light : pencil [visible red light : pencil, ballpoint pen (black or blue)]
		Reading marks	size: 0.5×3mm or more darkness: PCS 0.6 or darker
	Barcode		(*Optional barcode unit is necessary to use the barcode function. The selecting "V" or "H" depends on the reading direction of the bar direction. See P90-P96)
		Barcode styles	JAN/EAN/UPC/NW7/CODE39/CODE128/ ITF/code corresponding to the model of the device (Vertical: COOP 2 of 5, industrial 2 of 5) (Horizontal: EAN-128, CODE-93) (*As for entire thickness at time of bar-code label use 0.25 mm or less)
	Error detection function	Sheet position detection, multiple sheet feeding detection, skew detection	
	Printing	(*The printer function requires the optional stacker unit or printer unit.)	
	PC interface	USB (Ver. 2.0)	480Mbps
		RS-232C	9,600-115,200bps
	Display panel and operating switches	Display panel (LCD)	20 characters x 2 lines
		Operating switches	5
	Hopper capacity	500 sheets (paper weight 105g/m ²)	
	Paper used	Paper size	IBM card size, postcard size, A5, B5, A4 8.5 inch, 9 inch Height 110-355.6mm, width 63.5-228.6mm
		Paper weight	84-157g/m ²
		Paper quality	OCR paper, bond paper, recycled OCR paper (recycled OCR paper composition 50%)
	Sheet feeding	Feeding speed	550mm/s Approx. 3,500 sheets/hour (single-sided using a USB connection)
	Sheet discharge	Stacker volume	500 sheets (when weight 105g/m ² paper is used)
		Stacker function	Yes (*Optional stacker unit is necessary to use the stacker function) Main tray: 500 sheets (when weight 105g/m ² paper is used) Selection tray: 150 sheets (when weight 105g/m ² paper is used)
		Reverse discharge	Yes (*When stacker unit is installed)
	Power source	AC100-240V, 50Hz/60Hz	
	Environmental operating conditions	Temperature	5-35°C
		Humidity	30-80%
	External measurements	365(W) x 227(H) x 575(D) mm (when paper receiver is installed 947(D) mm)	
	Weight	17kg (excluding optional items)	
	Noise	60dB(A)(when operating) [] Inside option	

Product specifications(SR-6500)

Sensor	Reading	Single sided, [double-sided] (* You need an optional back-surface reading unit for double-sided reading.)
	Darkness levels	16 levels (internal 256 levels)
	Light source color	infra red light (940nm) [visible red light (660nm)]
	Pitch (inch)	1/6", 0.2", 0.25", 0.3"
	Marking	infra red light : pencil [visible red light : pencil, ballpoint pen (black or blue)]
	Reading marks	size: 0.5×3mm or more darkness: PCS 0.6 or darker
	Barcode	(*Optional barcode unit is necessary to use the barcode function. The selecting "V" or "H" depends on the reading direction of the bar direction. See P90-P96)
	Barcode styles	JAN/EAN/UPC/NW7/CODE39/CODE128/ ITF/code corresponding to the model of the device (Vertical: COOP 2 of 5, industrial 2 of 5) (Horizontal: EAN-128, CODE-93) (*As for entire thickness at time of bar-code label use 0.25 mm or less)
Error detection function	Sheet position detection, multiple sheet feeding detection, skew detection	
Printing	Comes with the stacker unit	
PC interface	USB (Ver. 2.0)	480Mbps
	RS-232C	9,600-115,200bps
Display panel and operating switches	Display panel (LCD)	20 characters x 2 lines
	Operating switches	5
Hopper capacity	500 sheets (paper weight 105g/m ²)	
Paper used	Paper size	IBM card size, postcard size, A5, B5, A4
		8.5 inch, 9 inch
		Height 110-355.6mm, width 63.5-228.6mm
	Paper weight	84-157g/m ²
	Paper quality	OCR paper, bond paper, recycled OCR paper (recycled OCR paper composition 50%)
Sheet feeding	Feeding speed	1,100mm/s (1,000mm/s when using the barcode)
		Approx. 5,300 sheets/hour (single-sided using a USB connection)
Sheet discharge	Stacker volume	Main tray: 150 sheets (when weight 105g/m ² paper is used)
		Selection tray: 500 sheets (when weight 105g/m ² paper is used)
Reverse discharge	Yes	
Power source	AC100-240V, 50Hz/60Hz	
Environmental operating conditions	Temperature	5-35°C
	Humidity	30-80%
External measurements	800(W) x 490(H) x 365(D) mm	
	Weight	36kg (excluding optional items)
	Noise	65dB(A)(when operating) [] Inside option

Operation

■ Preparation (SR-3500)

1. Protecting tapes are attached to the main device in the following positions to protect it from vibration and shock during transportation. Remove the protecting tapes after placing the device in an appropriate location.

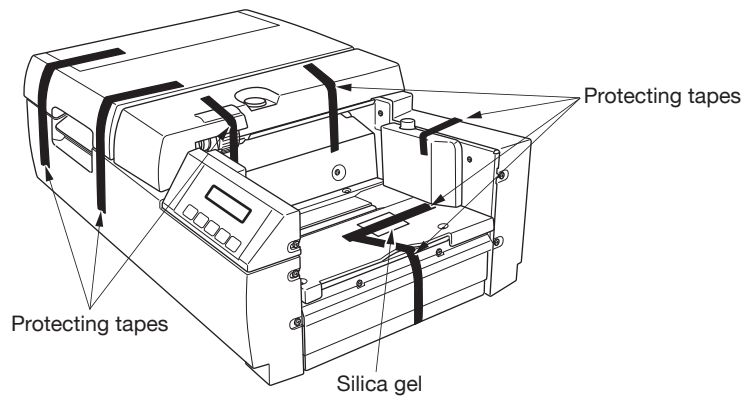

2. Install auxiliary brackets on the paper receiver.

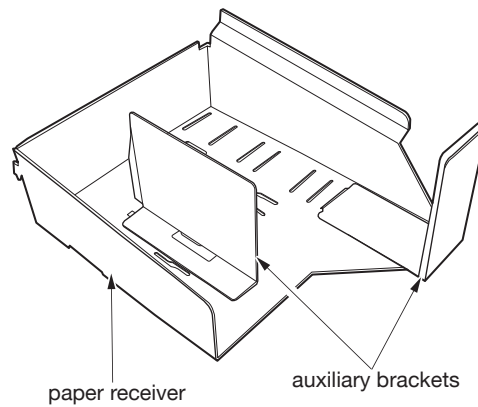

3. Install the paper receiver on the main device. Hook tabs on the end of the paper receiver into the slits of the main device's paper discharge side.

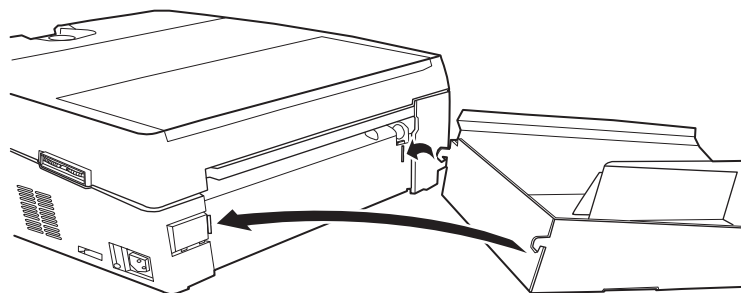

4. Connect the power cord to the main device.

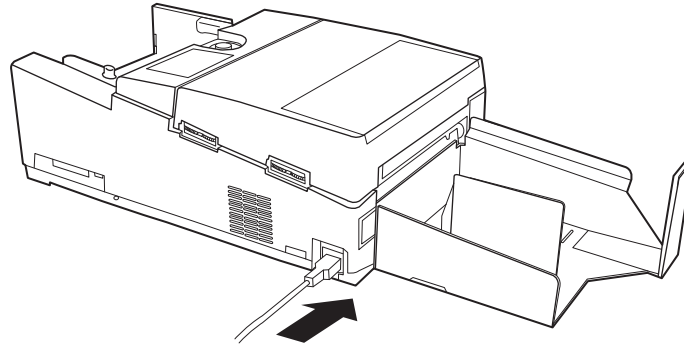

5. Connect the power cord to the power outlet.

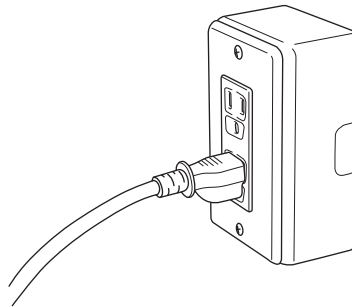

Operation

■ Preparation (when stacker unit installed)

1. Install the main tray on the main body unit. Hook the tabs on the end of the main tray into the slots on the main device's paper discharge side.

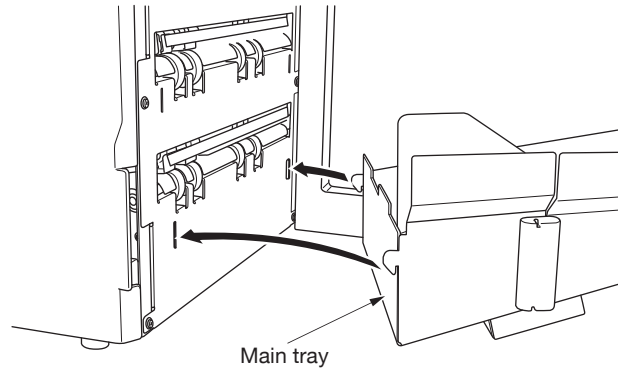

2. Install the selection tray on the main body unit. Hook the tabs on the end of the selection tray into the slots on the main device's paper discharge side.

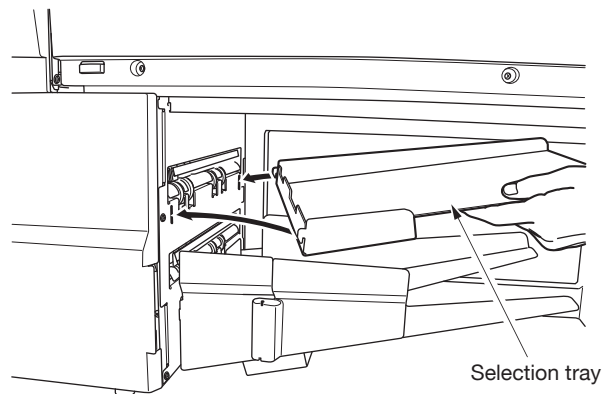

3. Connect the power cord to the main device.

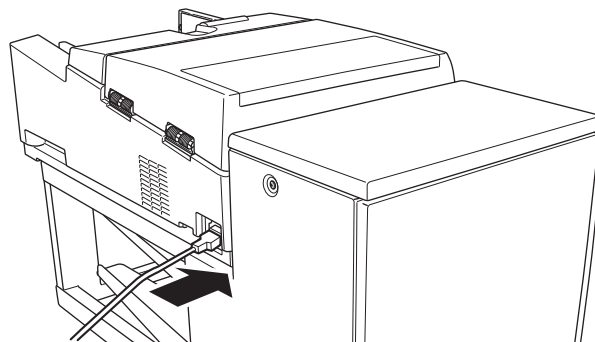

* When using the printer, operate P75 "Stacker unit (printer) preparation"

4. Connect the power cord to the power outlet.

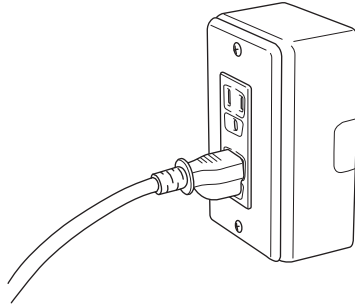

■ Turning power on

- 1.** Turn the power on. The following message appears on the display panel (LCD).

I n i t i a l i z i n g

- 2.** OMR is initialized.
- 3.** The motor and other components are activated to check startup conditions.
- 4.** Check if the following message appears on the display panel (LCD).

C o u n t : 0

- 5.** When error messages may appear between steps **2** and **3**, respond according to P.102(Error displays and countermeasures).

■ Loading paper

1. Load paper with the timing marks on the left side of the hopper. The hopper is set to drop when the power is turned on, but if it's still raised, press the DOWN switch in normal mode to lower the hopper. At this time, align paper carefully. Pay particular attention to the leading edges of the paper because feeding errors may occur unless the paper is properly aligned.

Note)

If the hand-fed mode is selected, the hopper is kept at the paper feed position.

2. Adjust the side guide in order to close a gap between the paper and the side guide then fix it with the side guide knob. Note a large gap because mark reading becomes unstable. When moving the side guide loosen the side guide knob. Then adjust and tighten the side guide knob and fix.

Note)

When the side guide is pushed to seat side too much, there are times when it becomes cause of no feed error.

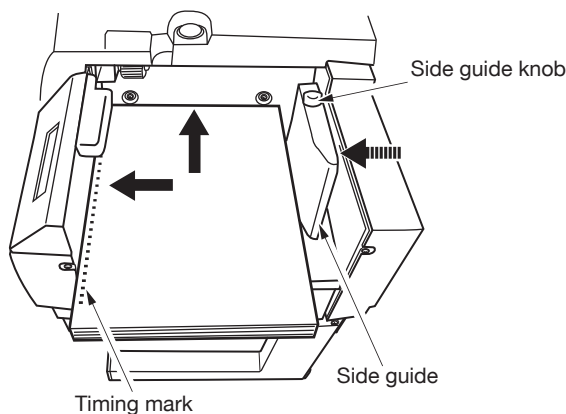

Note)

When using paper other than IBM card size, set the paper-feeding auxiliary bracket at the bottom end of the paper.

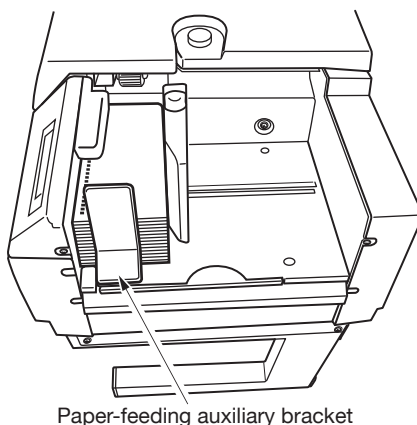

Note)

The aligning roller is fixed with the magnet. Check that there is not a gap and a floating on the adsorption aspect. In case of a certain pressing the panel side, make stick.

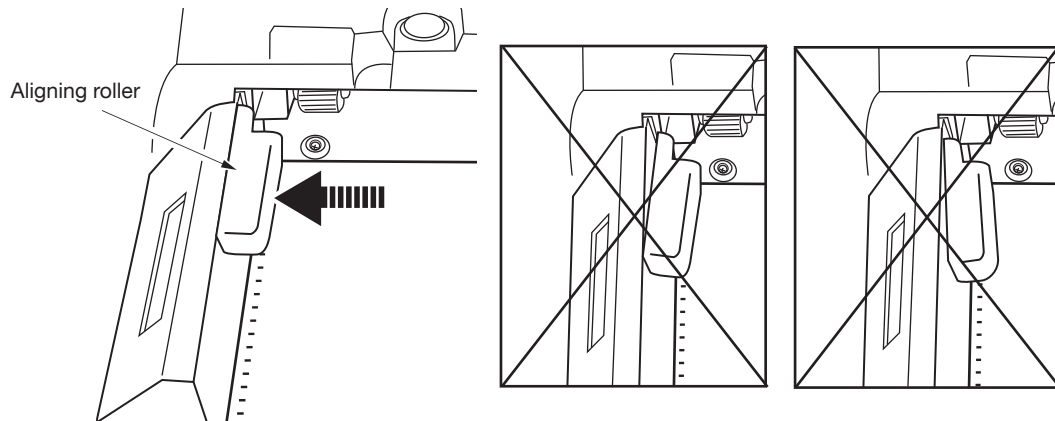

- 3.** To see the maximum number of cards that can be loaded into the hopper, refer to the side guide index. (A maximum of 500 sheets of 105g/m² weight paper.) Note that overloading may result in paper not feeding, or in reading errors.

Notes)

- 1) Carefully handle paper so that it is not bent or damaged. If bent or damaged sheets are used, paper may not feed or reading errors may occur.
- 2) Do not use paper in any of the following states:
Soiled or damaged paper, paper to which dust or other foreign matter adheres, curled paper or folded paper (folded in two, four, etc.)
- 3) When adding paper, lower the hopper and be sure to reset the paper. Be sure to loosen the sheets as shown in the left figure so as to prevent double feeding when sheets adhere to each other.
- 4) When storing paper, avoid keeping it in a place subject to sudden environmental changes. Pay thorough attention to moisture and keep paper in a cabinet or other safe place. Do not leave paper in a dusty place such as near a window.
- 5) Because the aligning roller section has used the magnet, do not bring close a floppy disk and magnetic card etc...



■ Setting paper weight

1. The device is equipped with a function to detect double-feeding (DF) errors. Conduct [Paper Weight]*1 according to the thickness of the paper to be used.

*1 Setting reading (initially set to a paper weight of 105g/m².)

See “Data reading settings ■ setting paper weight” in this manual. P.46

Set the paper weight dial to prevent double feeding.

Paper weight value is for reference only, so adjust it according to the condition of the paper to be used.

2. There is a mechanism which adjusts paper interval with the paper weight dial to prevent double feeding. Adjusts the paper weight dial to the sheet which you use.

Note)

1. Because as for thickness of the sheet there is a variation depending upon papery quality, increase and decrease with conveying circumstance.
2. When it sets extremely small (narrow), there are case which it becomes cause of the paper clogging and the sheet skew.

*2 Setting paper weight dial (initially set to a paper weight of 105g/m².)

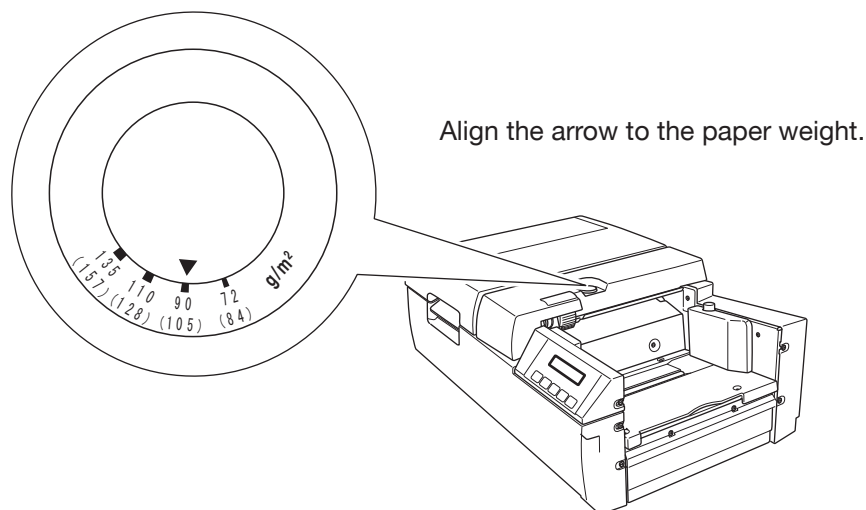

Marking instructions

Marks readable by this device are as follows.

- 1) Mark size: 0.5 x 3mm or more (standard mark)
- 2) Readable writing instruments: pencils (black, HB or darker), ballpoint pens (black or blue)
- 3) Readable marks:

(Good mark example)



(Bad mark example)



- 4) Readable darkness: PCS 0.6 or darker
Readable mark darkness can be adjusted.
You can check mark darkness using a diagnostic utility included in the package, so check the darkness of the marks you want to read and adjust the reading setting.



**“Data reading settings ■ Setting min. density Level”
in this manual on P.41**

**“Data reading settings ■ Setting density balance”
in this manual on P.42**

Note)

When using a mechanical pencil, make sure to mark with adequate darkness.

Connecting to a computer

This device is equipped with USB and RS-232C interfaces. When connecting the OMR, the connection with USB in order to show the performance of this device sufficiently is recommended. When connecting using USB, use the USB driver inside CR-ROM that came with this device.

When replacing the OMR SR-600, SR-9000 series with this device, you can use the RS-232C interface. ※ 1

When using the RS-232C interface, set the same communication setting on this device and the computer.

Set the computer communication setting by checking your computer or software manuals.

※ 1) There are times when it does not operate normally due to the environment of use.

See the following pages to set the communication setting for this device.

USB

Operating mode → select $\left(\begin{array}{l} \text{SR-3500 mode} \dots\dots\dots \text{P.31} \\ \text{SR-6500} \end{array} \right.$

Interface setting (device ID setting)..... P.32

- See P.31 and later when using USB.

RS-232C

Operating mode → select $\left(\begin{array}{l} \text{SR-600 mode} \dots\dots\dots \text{P.33} \\ \text{SR-9000} \end{array} \right.$

Interface settings

Setting baud rate P.34

Setting character bit length..... P.34

Setting parity P.35

Setting stop bit..... P.36

Setting flow control P.36

Setting character code..... P.37

- See P.33 and later when using RS-232C.

* SR-700 series can operate in SR-600 mode.



Note)

- * Responding time to resetting command(CAN command) which is stated in the operating manual of SR-600, SR-9000 series
Time after this device receiving resetting command(CAN command) , it return ACK code is maximum approximately 5.6 seconds.
- * As for the details of commands of SR-600 mode please see the operating manual of SR-600
- * As for the details of commands of SR-9000 mode please see the operating manual of SR-9000

■ USB

1. Operating mode

Select the SR-3500,SR6500 mode as the operating mode.

- (1) Press the  switch to enter the menu mode.
- (2) Use the  and  switches to select the mode shown below.

Operation Mode	(SR-3500)
= SR-600 Mode	

Operation Mode	(SR-6500)
= SR-9000 Mode	

Press the  switch to start [Operation Mode] setting.

("*" mark flashes in the first column of the first line on the LCD.)

- (3) Use the  and  switches to select the SR-3500,6500 mode.

* Operation Mode	
= SR-3500 Mode	



Operation mode setting values	(SR-3500)
• SR-600 mode	
• SR-3500 mode	

* Operation Mode	
= SR-6500 Mode	





Operation mode setting values	(SR-6500)
• SR-9000 mode	
• SR-6500 mode	

Press the  switch to save the selected mode into memory.

(The flashing "*" mark disappears from the LCD.)

- (4) Keep pressing the  switch until it returns to normal mode, or press the  switch to return to normal mode.

2. Interface settings

- (1) Press the  switch to enter the menu mode.
- (2) Use the  and  switches to select the following parameters, and press the  switch.



S e t t i n g o f
I n t e r f a c e

- (3) Use the  and  switches to select the following parameters,



* D e v i c e I D = 0

and press the  switch to begin [Device ID] setting.

(* mark flashes in the first column of the first line on the LCD.)

Set any number using the  and  switches.



Device ID
setting value
0-126

- (4) Press the  switch to save the setting value into memory.
(The flashing "*" mark disappears from the LCD.)
- (5) Keep pressing the  switch until it returns to normal mode, or press the  switch to return to normal mode.

■ RS-232C

1. Operating mode

Select the SR-600,SR-9000 mode as the operating mode.

- (1) Press the  switch to enter the menu mode.
- (2) Use the  and  switches to select the mode shown below.

Operation Mode = SR-3500 Mode	(SR-3500)
----------------------------------	-----------

Operation Mode = SR-6500 Mode	(SR-6500)
----------------------------------	-----------

Press the  switch to start [Operation Mode] setting.

("*" mark flashes in the first column of the first line on the LCD.)

- (3) Use the  and  switches to select the SR-600 mode.

* Operation Mode = SR-600 Mode	
-----------------------------------	--



Operation mode setting values • SR-600 mode • SR-3500 mode	(SR-3500)
--	-----------

* Operation Mode = SR-9000 Mode	
------------------------------------	--

Operation mode setting values • SR-9000 mode • SR-6500 mode	(SR-6500)
---	-----------





Press the  switch to save the selected mode into memory.

(The flashing "*" mark disappears from the LCD.)





- (4) Keep pressing the  switch until it returns to normal mode, or press the  switch to return to normal mode.

2. Interface settings

2-1. Setting baud rate



- (1) Press the  switch to enter the menu mode.
- (2) Use the  and  switches to select the following parameters, and press the  switch.

S e t t i n g o f
I n t e r f a c e

- (3) Use the  and  switches to select [Baud Rate] setting, and press the  switch.
(* mark flashes in the first column of the first line on the LCD.)
- (4) Use the  and  switches to set the value.

* B a u d R a t e
= 3 8 4 0 0





Baud rate
setting values
• 9600 • 19200
• 38400 • 57600
• 115200

- (5) Press the  switch to save the setting value into memory.
(The flashing "*" mark disappears from the LCD.)
- (6) Keep pressing the  switch until it returns to normal mode, or press the  switch to return to normal mode.





Note) To continue interface setting

Instead of returning to normal mode in step (6), you can continue setting various values by skipping steps (1) and (2).

2-2. Setting character bit length



- (1) Press the  switch to enter the menu mode.
- (2) Use the  and  switches to select the following parameters, and press the  switch.

S e t t i n g o f
I n t e r f a c e





- (3) Use the  and  switches to select [Character Bit Length] setting, and press the  switch.
(“*” mark flashes in the first column of the first line on the LCD.)
- (4) Use the  and  switches to set the value.

* C h a r a c t e r B i t
L e n g t h = 7





Character bit length
value
• 7 • 8

- (5) Press the  switch to save the setting value into memory.
(The flashing “*” mark disappears from the LCD.)
- (6) Keep pressing the  switch until it returns to normal mode, or press the  switch to return to normal mode.

2-3. Setting parity



- (1) Press the  switch to enter the menu mode.
- (2) Use the  and  switches to select the following parameters, and press the  switch.

S e t t i n g o f
I n t e r f a c e





- (3) Use the  and  switches to select [Parity] setting, and press the  switch.
(“*” mark flashes in the first column of the first line on the LCD.)
- (4) Use the  and  switches to set the value.

* P a r i t y
= N o n e





Parity setting values
• None
• Odd • Even

- (5) Press the  switch to save the setting value into memory.
(The flashing “*” mark disappears from the LCD.)
- (6) Keep pressing the  switch until it returns to normal mode, or press the  switch to return to normal mode.

2-4. Setting stop bit



- (1) Press the  switch to enter the menu mode.
- (2) Use the  and  switches to select the following parameters, and press the  switch.

S e t t i n g o f I n t e r f a c e
--





- (3) Use the  and  switches to select [Stop Bit] setting, and press the  switch.
(* mark flashes in the first column of the first line on the LCD.)
- (4) Use the  and  switches to set the value.

* S t o p B i t	= 1
-------------------	-------



Stop bit setting values
• 1 • 2

- (5) Press the  switch to save the setting value into memory.
(The flashing "*" mark disappears from the LCD.)
- (6) Keep pressing the  switch until it returns to normal mode, or press the  switch to return to normal mode.

2-5. Setting flow control

- (1) Press the  switch to enter the menu mode.
- (2) Use the  and  switches to select the following parameters, and press the  switch.



S e t t i n g o f I n t e r f a c e
--

- (3) Use the  and  switches to select [Flow Control] setting, and press the  switch.
(* mark flashes in the first column of the first line on the LCD.)





- (4) Use the  and  switches to set the value.

* F l o w C o n t r o l
= R S / C S





Flow control
setting values
• RS/CS • Xon/Xoff
• None

- (5) Press the  switch to save the setting value into memory.
(The flashing “*” mark disappears from the LCD.)
(6) Keep pressing the  switch until it returns to normal mode,
or press the  switch to return to normal mode.

2-6. Setting character code



- (1) Press the  switch to enter the menu mode.
(2) Use the  and  switches to select the following parameters,
and press the  switch.

S e t t i n g o f
I n t e r f a c e

- (3) Use the  and  switches to select [Character Code] setting,
and press the  switch.
(“*” mark flashes in the first column of the first line on the LCD.)
(4) Use the  and  switches to set the value.

* C h a r a c t e r C o d e
= A c c e p t A l l

Character code
setting values
• Accept All
• Ignore 4 Codes
If ignore some is
selected, the following
codes are ignored.
• 20H • 0AH
• 7FH • 1AH

- (5) Press the  switch to save the setting value into memory.
(The flashing “*” mark disappears from the LCD.)
(6) Keep pressing the  switch until it returns to normal mode,
or press the  switch to return to normal mode.





Data reading settings

This section explains how to change various sheet-reading settings.
All settings can also be made using computer commands.



■ Setting column

Set the column. The number of columns is different depending on the reading sensor.

Sensor pitch	Setting range	Default value
1/6 inch	1-48 columns	48 columns
0.2 inch	1-40 columns	40 columns
0.25 inch	1-33 columns	33 columns
0.3 inch	1-27 columns	27 columns

1. Press the  switch to enter the menu mode.
2. Use the  and  switches to select the following parameters, and press the  switch.

S e t t i n g o f R e a d i n g



3. Use the  and  switches to select [Setting of Column] setting, and press the  switch.

("*" mark flashes in the first column of the first line on the LCD.)

4. Use the  and  switches to set the value.

* S e t t i n g o f C o l u m n
= 4 8 C o l u m n s

Column setting values
1 - maximum columns

5. Press the  switch to save the setting value into memory.
(The flashing "*" mark disappears from the LCD.)
6. Keep pressing the  switch until it returns to normal mode, or press the  switch to return to normal mode.

Note)





It is necessary to set the number of columns with each operation mode.

■ Setting reading method





Setting mark-reading method.

There are six kinds of reading methods: “Top-end timing control type,” “Bottom-end timing control type,” “Direct under type,” “FACOM,” “Mark to mark type (without top-end margin reading),” and “Mark to mark type (with top-end margin reading).”

When setting to “top-end timing control type” or “bottom-end timing control type,” you need to set a control multiple number.

1. Press the  switch to enter the menu mode.
2. Use the  and  switches to select the following parameters, and press the  switch.



Setting of Reading

3. Use the  and  switches to select [Reading Method] setting, and press the  switch.
(“*” mark flashes in the first column of the first line on the LCD.)
4. Use the  and  switches to set the value.





*Reading Method
= Direct

Reading method
setting values



- Control Fore
- Control Back
- Direct
- FACOM
- Mark to Mark
- Mark to Mark *

5. Press the  switch to save the setting value into memory.
(The flashing “*” mark disappears from the LCD.)
6. Keep pressing the  switch until it returns to normal mode, or press the  switch to return to normal mode.

Setting magnification when timing control types are selected

1. Press the  switch to enter the menu mode.
2. Use the  and  switches to select the following parameters, and press the  switch.

Setting of Reading

3. Use the  and  switches to select [Magnification] setting, and press the  switch.



("*" mark flashes in the first column of the first line on the LCD.)

4. Use the  and  switches to set the value.

* M a g n i f i c a t i o n
= 3 T i m e s





Magnification setting values

- Top-end timing control type
1 - 9 (times)
- Bottom-end timing control type
2 - 9 (times)





5. Press the  switch to save the setting value into memory.
(The flashing "*" mark disappears from the LCD.)
6. Keep pressing the  switch until it returns to normal mode, or press the  switch to return to normal mode.

■ Setting min. density level

You can set the min. density level for this device when it is in SR-600/SR-9000 operating mode. Sensitivity levels range from 1 to 16, with level 1 being the maximum sensitivity and level 16 the lowest sensitivity.



1. Press the  switch to enter the menu mode.
2. Use the  and  switches to select the following parameters, and press the  switch.

Setting of Reading

3. Use the  and  switches to select [Min. Density Level] setting, and press the  switch.
(“*” mark flashes in the first column of the first line on the LCD.)
4. Use the  and  switches to set the value.

* Min . Density Level = 4

Min. density level
setting values
1 - 16





5. Press the  switch to save the setting value into memory.
(The flashing “*” mark disappears from the LCD.)
6. Keep pressing the  switch until it returns to normal mode, or press the  switch to return to normal mode.

SR-3500 SR-6500 min. density level	SR-600 SR-9000 mode min. density level	SR-3500 SR-6500 min. density level	SR-600 SR-9000 mode min. density level	SR-3500 SR-6500 min. density level	SR-600 SR-9000 mode min. density level
1	1	7	5~6	12	10~11
2	1~2	8	6~7	13	10~11
3	2~3	9	7~8	14	11~12
4	3~4	10	8~9	15	12~13
5	4~5	11	9~10	16	13~14
6	5~6				





- *1. The above sensitivity level is a standard table under a complete marked mark of grid width for 3mm in 105g/m² paper thickness.
- *2. The sensitivity level varies depending on marks because reading method is different each other.
- *3. When you use this device in compatible mode, the verification by you is necessary .

■ Setting density balance

You can set the density balance level when using the SR-600/SR-9000 operating mode. Density balance can be set so that when marks are read, marks lighter than the set density balance will be ignored, and marks darker than the set density balance will be detected. Density balance can be set from 1 to 15.



1. Press the  switch to enter the menu mode.
2. Use the  and  switches to select the following parameters, and press the  switch.

S e t t i n g o f R e a d i n g

3. Use the  and  switches to select [Density Balance] setting, and press the  switch.
(“*” mark flashes in the first column of the first line on the LCD.)
4. Use the  and  switches to set the value.

* D e n s i t y B a l a n c e
= 1

Density balance
setting values
1 - 15





5. Press the  switch to save the setting value into memory.
(The flashing “*” mark disappears from the LCD.)
6. Keep pressing the  switch until it returns to normal mode, or press the  switch to return to normal mode.

Note)





See the operating manual of each type in regard to density balance.

■ Setting reading side

You can set the reading side when the optional back-sided reading unit is installed. The reading side can be set to either “single side” or “double side.” When reading single-sided sheets, if you set the reading side to “single side,” the back side won’t be read.



1. Press the  switch to enter the menu mode.
2. Use the  and  switches to select the following parameters, and press the  switch.

S e t t i n g o f R e a d i n g

3. Use the  and  switches to select [Reading Side] setting, and press the  switch.
(“*” mark flashes in the first column of the first line on the LCD.)
4. Use the  and  switches to set the value.

* R e a d i n g S i d e
= D o u b l e S i d e

Reading side
setting values
• Single Side
• Double Side





5. Press the  switch to save the setting value into memory.
(The flashing “*” mark disappears from the LCD.)
6. Keep pressing the  switch until it returns to normal mode, or press the  switch to return to normal mode.

■ Setting hopper mode





Setting the hopper mode for reading sheets.

The hopper mode can be set to either "ADF" or "manual feed."

If you set it to "manual feed," you need to set the sheet insertion waiting time.

- 1.** Press the  switch to enter the menu mode.
- 2.** Use the  and  switches to select the following parameters, and press the  switch.



Setting of Reading

- 3.** Use the  and  switches to select [Hopper Mode] setting, and press the  switch.
("*" mark flashes in the first column of the first line on the LCD.)
- 4.** Use the  and  switches to set the value.





* H o p p e r M o d e = A D F

- hopper mode setting values





 - ADF
 - Manual Feed

- 5.** Press the  switch to save the setting value into memory.
(The flashing "*" mark disappears from the LCD.)
- 6.** Keep pressing the  switch until it returns to normal mode, or press the  switch to return to normal mode.

Set sheet insertion waiting time when "manual feed" is selected

- 1.** Press the  switch to enter the menu mode.
- 2.** Use the  and  switches to select the following parameters, and press the  switch.



Setting of Reading

- 3.** Use the  and  switches to select [Wait Time for Form] setting, and press the  switch.
(“*” mark flashes in the first column of the first line on the LCD.)
- 4.** Use the  and  switches to set the value.

* Wait Time for Form
= 10 s

Wait time for form
setting values

- None
- 1-99S

- 5.** Press the  switch to save the setting value into memory.
(The flashing “*” mark disappears from the LCD.)
- 6.** Keep pressing the  switch until it returns to normal mode, or press the  switch to return to normal mode.





*The hopper table goes up and kept at the upper position if the manual mode is selected. The hopper dose not go down if the  switch is pressed.

■ Setting paper weight





Set detection sensitivity in the same paper weight as seat of use to detect double-feeding errors. Paper weight can be set according to the following five types: "Automatic," "84g/m²," "105g/m²," "128g/m²," and "157g/m²."

If it's set to "Automatic," the device detects double-feeding errors based on the weight of first sheet read after the device is activated.

Also, in case it is set to "Automatic", if the count is set to "0", all the information of the paper weight is cleared, and the device detects the double-feeding error based on the paper weight after the device reads the first sheet.

1. Press the  switch to enter the menu mode.
2. Use the  and  switches to select the following parameters, and press the  switch.



Setting of Reading

3. Use the  and  switches to select [Paper Weight] setting, and press the  switch.
("*" mark flashes in the first column of the first line on the LCD.)
4. Use the  and  switches to set the value.

* P a p e r W e i g h t
= 1 0 5 g / m 2

Paper weight setting values

- Automatic
- 84g/m²
- 105g/m²
- 128g/m²
- 157g/m²

5. Press the  switch to save the setting value into memory.
(The flashing "*" mark disappears from the LCD.)
6. Keep pressing the  switch until it returns to normal mode, or press the  switch to return to normal mode.





Note)

If it is set to "Automatic", paper weight is detected based on the weight of the first reading sheet so that it is required to confirm if the double-feeding error, etc., does not occur.





■ Setting Paper hold(SR-3500)

You can set paper hold setting when using SR-600 operating mode.

When paper hold setting is done, after reading, without discharging the sheet you keep on the inside of this device. The processing number of cards improves with this operation. (It is the same operation as SR-3500 mode.) However It cannot maintain compatibility when the software is kept using with replacing OMR SR-600

1. Press the  switch to enter the menu mode.
2. Use the  and  switches to select the following parameters, and press the  switch.



S e t t i n g o f R e a d i n g

3. Use the  and  switches to select [Paper Hold] setting, and press the  switch.
(“*” mark flashes in the first column of the first line on the LCD.)
4. Use the  and  switches to set the value.

* P a p e r H o l d = N o t U s e

Paper hold
setting values

- Not use
- Use

5. Press the  switch to save the setting value into memory.
(The flashing “*” mark disappears from the LCD.)
6. Keep pressing the  switch until it returns to normal mode, or press the  switch to return to normal mode.

Error detection settings





Error detection settings for this device differ depending on the operating mode. See the following table for settings.

All settings can also be made using computer commands.



SR-3500 mode SR-6500 mode	Default value	SR-600 mode SR-9000 mode	Default value
Automatic paper discharge "Yes" or "No"	Yes		
Sheet empty detection "Yes" or "No"	No		
Timing error detection "Yes" or "No"	Yes		
Double-feeding detection "Yes" or "No"			Yes
Left end skew detection "Yes" or "No"			Yes





See "Error displays and countermeasures" in this manual on P.110-P.116.

Error detection settings

1. Press the  switch to enter the menu mode.
2. Use the  and  switches to select the following parameters, and press the  switch.

Setting of Error
Detection





3. Use the  and  switches to select Setting of Error Detection, and press the  switch.
("*" mark flashes in the first column of the first line on the LCD.)

- 4.** Use the  and  switches to select individual error detection setting values.
(See the previous table for setting values.)
- 5.** Press the  switch to save individual setting values into memory.
(The flashing “*” mark disappears from the LCD.)
- 6.** Keep pressing the  switch until it returns to normal mode,
or press the  switch to return to normal mode.





Buzzer settings

You can set the device to either use the buzzer or not use it.
If you set it to use the buzzer, you can set the volume and tone.
If you set it not to use the buzzer, the buzzer will not sound.

■ Buzzer control

1. Press the  switch to enter the menu mode.
2. Use the  and  switches to select the following parameters, and press the  switch.



S e t t i n g o f B u z z e r

3. Use the  and  switches to select [Buzzer Control] setting, and press the  switch.
(“*” mark flashes in the first column of the first line on the LCD.)
4. Use the  and  switches to set the value.





* B u z z e r C o n t r o l = V a l i d

Buzzer control
setting values





- Valid
- Invalid

5. Press the  switch to save the setting value into memory.
(The flashing “*” mark disappears from the LCD.)
6. Keep pressing the  switch until it returns to normal mode, or press the  switch to return to normal mode.

■ Buzzer sound adjustment



1. Press the  switch to enter the menu mode.
2. Use the  and  switches to select the following parameters, and press the  switch.

S e t t i n g o f B u z z e r

3. Use the  and  switches to select [Buzzer Sound Adjustment] setting, and press the  switch.
(“*” mark flashes in the first column of the first line on the LCD.)
4. Use the  and  switches to set the value.





* B u z z e r S o u n d
A d j u s t m e n t = 3

Buzzer sound adjustment
setting values
1 - 5





5. Press the  switch to save the setting value into memory.
(The flashing “*” mark disappears from the LCD.)
6. Keep pressing the  switch until it returns to normal mode, or press the  switch to return to normal mode.

Stacker settings (when stacker unit is installed)

You can set the paper discharge direction in SR-600/SR-9000 mode.



1. Press the  switch to enter the menu mode.
2. Use the  and  switches to select the following parameters, and press the  switch.

S e t t i n g o f S t a c k e r

3. Use the  and  switches to select [Go Out Direction] setting, and press the  switch.
(“*” mark flashes in the first column of the first line on the LCD.)
4. Use the  and  switches to set the value.

* G o O u t D i r e c t i o n
= M a i n

Stacker go out direction
setting values
• Main • Select

5. Press the  switch to save the setting value into memory.
(The flashing “*” mark disappears from the LCD.)
6. Keep pressing the  switch until it returns to normal mode, or press the  switch to return to normal mode.

Printer settings (when stacker unit or printer unit are installed)

A character is 12 x 9 pixels.

Though character height is fixed (about 3mm), widths can vary.



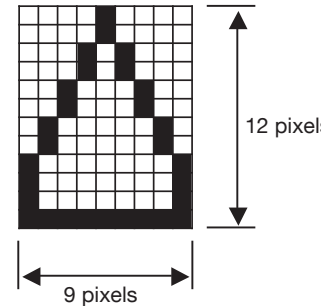

However, the number of pixels (9 pixels) does not change, so if you enlarge a character, the space between pixels increases, making the character appear lighter.

Printer settings differ depending on the operating mode.





Printer control

You can set the device to either use the printer or not use it. If you do not use the printer function, set the invalid.

1. Press the  switch to enter the menu mode.
2. Use the  and  switches to select the following parameters, and press the  switch.



S e t t i n g o f P r i n t e r

3. Use the  and  switches to select [Printer Control] setting, and press the  switch.
 (“*” mark flashes in the first column of the first line on the LCD.)

4. Use the  and  switches to set the value.

* P r i n t e r C o n t r o l
 = V a l i d

Printer control
 setting values
 • Valid
 • Invalid

5. Press the  switch to save the setting value into memory.
 (The flashing “*” mark disappears from the LCD.)
6. Keep pressing the  switch until it returns to normal mode, or press the  switch to return to normal mode.

SR-3500,SR-6500 mode

- Character size setting P.54
- Character interval setting P.55
- See P.54 and subsequent pages for SR-3500,SR-6500 mode.

SR-600,SR-9000 mode

- Character size setting P.57
- Character magnification setting P.58
- Character interval setting P.59
- See P.57 and subsequent pages for SR-600,SR-9000 mode.





■ SR-3500,SR-6500 mode

1. Character size setting

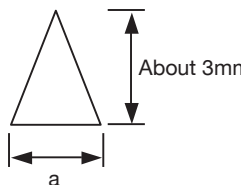

The width of a character can be increased in 0.8mm increments between 3.2mm and 6.4mm.

No.	Size (a)
1	3.2mm
2	4.0mm
3	4.8mm
4	5.6mm
5	6.4mm

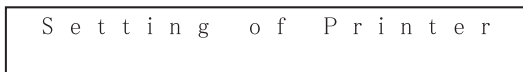

- (1) Press the  switch to enter the menu mode.
- (2) Use the  and  switches to select the following parameters, and press the  switch.





- (3) Use the  and  switches to select [Size] setting, and press the  switch.
 ("*" mark flashes in the first column of the first line on the LCD.)

- (4) Use the  and  switches to set the value.

* S i z e = 3 . 2 m m

Character size setting values
3.2 - 6.4 (mm)
0.8mm increments

- (5) Press the  switch to save the setting value into memory.
(The flashing “*” mark disappears from the LCD.)
- (6) Keep pressing the  switch until it returns to normal mode, or press the  switch to return to normal mode.

[Setting example 1]
When the size is set at 3.2mm



[Setting example 2]
When the size is set at 6.4mm

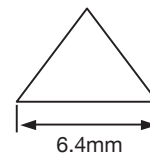





2. Character interval setting

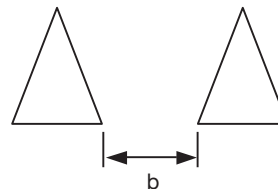



The space between printed characters can be increased in 0.1mm increments between 0.8mm to 92mm.

No.	Interval (b)
1	0.8mm
2	0.9mm
3	1.0mm
:	:
911	91.8mm
912	91.9mm
913	92.0mm





- (1) Press the  switch to enter the menu mode.
- (2) Use the  and  switches to select the following parameters, and press the  switch.

S e t t i n g o f P r i n t e r

- (3) Use the  and  switches to select [Character Pitch] setting, and press the  switch.
 (“*” mark flashes in the first column of the first line on the LCD.)
- (4) Use the  and  switches to set the value.

* C h a r a c t e r P i t c h
= 0 . 8 m m

Character pitch
setting values
0.8 - 92.0 (mm)
0.1mm increments

- (5) Press the  switch to save the setting value into memory.
 (The flashing “*” mark disappears from the LCD.)
- (6) Keep pressing the  switch until it returns to normal mode, or press the  switch to return to normal mode.

[Setting example 1]

When the size is set at 3.2mm and the interval is 0.8mm.

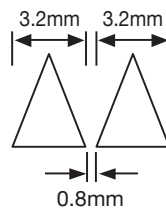

[Setting example 2]



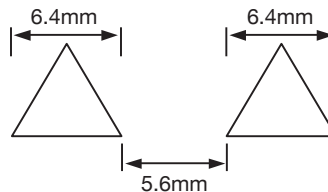

When the size is set at 6.4mm and the interval is 5.6mm.







2. Character magnification setting

Width can be magnified between 1 to 15 times.

Character width = size x magnification



- (1) Press the  switch to enter the menu mode.
- (2) Use the  and  switches to select the following parameters, and press the  switch.

S e t t i n g o f P r i n t e r

- (3) Use the  and  switches to select [Magnification] setting, and press the  switch.
(* mark flashes in the first column of the first line on the LCD.)
- (4) Use the  and  switches to set the value.

* M a g n i f i c a t i o n
= 1 T i m e

Character magnification
setting values
1 - 15 (Times)

- (5) Press the  switch to save the setting value into memory.
(The flashing "*" mark disappears from the LCD.)
- (6) Keep pressing the  switch until it returns to normal mode, or press the  switch to return to normal mode.

[Setting example 1]

When the size is set at 3.2mm and magnification is 1.
Character width = 3.2 x 1 = 3.2mm



[Setting example 2]

When the size is set at 3.2mm and magnification is 2.
Character width = 3.2 x 2 = 6.4mm

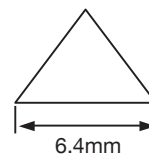

[Setting example 3]

When the size is set at 4.0mm and magnification is 2.
Character width = 4.0 x 2 = 8.0mm

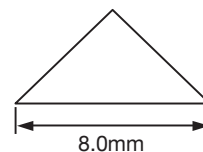





3. Character interval setting

The space between printed characters can be increased between 0 to 99 pixels. The actual character interval (in mm units) is determined by the “size,” “magnification,” and “interval” settings.

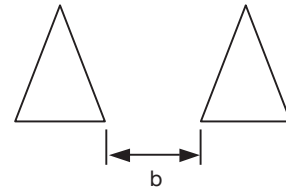

Character interval (b) = character interval increment x (magnification + interval + 1)

No.	Size	character interval increment
1	3.2mm	0.4mm
2	4.0mm	0.5mm
3	4.8mm	0.6mm
4	5.6mm	0.7mm
5	6.4mm	0.8mm

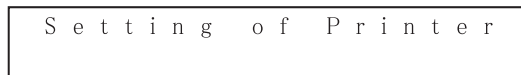

- (1) Press the  switch to enter the menu mode.
- (2) Use the  and  switches to select the following parameters, and press the  switch.





- (3) Use the  and  switches to select [Character Pitch] setting, and press the  switch.

(“*” mark flashes in the first column of the first line on the LCD.)

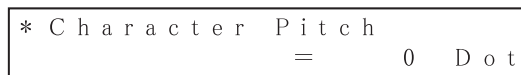
- (4) Use the  and  switches to set the value.



Character pitch
setting values
0 - 99 (Dots)

- (5) Press the  switch to save the setting value into memory.
(The flashing “*” mark disappears from the LCD.)
- (6) Keep pressing the  switch until it returns to normal mode, or press the  switch to return to normal mode.

[Setting example 1]

When the size is set at 3.2mm, the magnification is 1, and the interval is 0 pixel.

$$\text{Character interval} = 0.4 \times (1 + 0 + 1) = 0.8\text{mm}$$

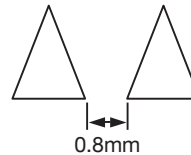

[Setting example 2]

When the size is set at 6.4mm, the magnification is 1, and the interval is 5 pixels.

$$\text{Character interval} = 0.8 \times (1 + 5 + 1) = 5.6\text{mm}$$

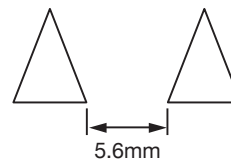

[Setting example 3]

When the size is set at 3.2mm, the magnification is 3, and the interval is 10 pixels.



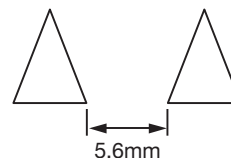

$$\text{Character interval} = 0.4 \times (3 + 10 + 1) = 5.6\text{mm}$$





Barcode settings (when barcode unit is installed)

You can set the barcode control in SR-3500,SR-6500 mode.

■ Barcode control

1. Press the  switch to enter the menu mode.
2. Use the  and  switches to select the following parameters, and press the  switch.

S e t t i n g o f B a r c o d e



3. Use the  and  switches to select [Go Out Direction] setting, and press the  switch.

("*" mark flashes in the first column of the first line on the LCD.)

4. Use the  and  switches to set the value.

* B a r c o d e C o n t r o l
= V a l i d

Barcode control
setting values
• Valid • Invalid

5. Press the  switch to save the setting value into memory.
(The flashing "*" mark disappears from the LCD.)
6. Keep pressing the  switch until it returns to normal mode, or press the  switch to return to normal mode.

Low power consumption settings

This device can be set to reduce power consumption in standby mode.





The low-power consumption settings make the device automatically reduce power consumption when it is not used for a certain period.

Sleep mode = low-power consumption condition that it automatically switches to when it is not used for a set time (sleep duration).



Standby mode = a second low-power consumption condition that it automatically and continuously switches to after shifting to the sleep mode when it is not used for a set time (standby duration).

(Power consumption is reduced further than sleep mode.)

■ Sleep duration

1. Press the  switch to enter the menu mode.
2. Use the  and  switches to select the following parameters, and press the  switch.

S e t t i n g o f
E l e c t r i c P o w e r

3. Use the  and  switches to select [Time for Power Save] setting, and press the  switch.

("*" mark flashes in the first column of the first line on the LCD.)



4. Use the  and  switches to set the value.

* T i m e f o r P o w e r S a v e
= 5 M i n u t e s





Time for Power Save
setting values

- None
- 1 - 60 (Minutes)





*Can be set in minute increments.

5. Press the  switch to save the setting value into memory.
(The flashing "*" mark disappears from the LCD.)
6. Keep pressing the  switch until it returns to normal mode, or press the  switch to return to normal mode.

■ Standby duration

1. Press the  switch to enter the menu mode.
2. Use the  and  switches to select the following parameters, and press the  switch.

S e t t i n g o f
E l e c t r i c P o w e r



3. Use the  and  switches to select [Time for Standby] setting, and press the  switch.
(“*” mark flashes in the first column of the first line on the LCD.)
4. Use the  and  switches to set the value.

* T i m e f o r S t a n d b y
= 5 M i n u t e s

Time for Standby
setting values

- None
- 1 - 60 (Minutes)

*Can be set in minute increments.

5. Press the  switch to save the setting value into memory.
(The flashing “*” mark disappears from the LCD.)
6. Keep pressing the  switch until it returns to normal mode, or press the  switch to return to normal mode.

Note)





- (1) Releasing Sleep/Standby mode
Sleep/Standby mode will be cancelled in the following conditions.
 - When an operation is entered on the panel screen.
 - When a descending command is sent.
 - When an error occurs.
 - When loading paper on the hopper.
- (2) Conditions in which Sleep/Standby mode cannot be attained
Sleep/Standby mode is not available in the following conditions.
 - When displaying a menu on the panel screen.
 - When an error occurs.
- (3) Stacker cover open error cannot be detected in Standby mode.

Displaying various information

This section explains how to display various setting information.

■ Displaying the version

This displays the versions of the “main body unit,” “front side reading unit,” “back side reading unit,” “stacker unit,” “printer unit,” “barcode unit” and other items. (“Back side reading unit,” “stacker unit,” “printer unit,” and “barcode unit” display only if they are installed.) Versions are displayed in a two-digit format.

1. Press the  switch to enter the menu mode.
2. Use the  and  switches to select the following parameters, and press the  switch.

D i s p l a y M o d e

3. Use the  and  switches to select [Version Info.], and press the  switch.





Note)

If “Version= @@” appears in the display, contact the store where you bought.

M a i n B o d y U n i t
V e r s i o n = 0 0





The present version is displayed. 

The name of each unit is displayed. 





4. Use the  and  switches to display individual versions.
5. Keep pressing the  switch until it returns to normal mode, or press the  switch to return to normal mode.

■ Displaying front side reading sensor settings

This displays the settings for “sensor pitch” and “sensor type” for the front side reading unit in this device.

1. Press the  switch to enter the menu mode.
2. Use the  and  switches to select the following parameters, and press the  switch.

D i s p l a y M o d e

3. Use the  and  switches to select [Type of Front Reading Sensor] display, and press the  switch.
4. Use the  and  switches to display the settings.

Sensor pitch



S e n s o r P i t c h
= 0 . 2 i n c h

Sensor pitch display
• 0.2 inch • 0.25 inch
• 0.3 inch • 1/6 inch

Sensor type





S e n s o r o f T y p e
= I n f r a R e d

Sensor type display
• Infra Red
• Visible Red





5. Keep pressing the  switch until it returns to normal mode, or press the  switch to return to normal mode.

■ Displaying back side reading sensor settings

This displays the settings for “sensor pitch” and “sensor type” for the back side reading unit in this device. (This display is available only when the device has a back side reading unit attached.)

1. Press the  switch to enter the menu mode.
2. Use the  and  switches to select the following parameters, and press the  switch.

D i s p l a y M o d e

3. Use the  and  switches to select [Type of Back Reading Sensor] display, and press the  switch.
4. Use the  and  switches to display the settings.

Sensor pitch



S e n s o r P i t c h
= 0 . 2 i n c h

Sensor pitch display
 • 0.2 inch • 0.25 inch
 • 0.3 inch • 1/6 inch

Sensor type





S e n s o r o f T y p e
= I n f r a R e d

Sensor type display
 • Infra Red
 • Visible Red





5. Keep pressing the  switch until it returns to normal mode, or press the  switch to return to normal mode.

■ Displaying optional unit settings

This displays the settings for an optional unit installed in this device.

1. Press the  switch to enter the menu mode.
2. Use the  and  switches to select the following parameters, and press the  switch.

Display Mode

3. Use the  and  switches to select [Type of Option] display, and press the  switch.
4. Use the  and  switches to display the options.

Reading sensor unit

Reading Sensor Unit
= Single Side

Reading sensor unit display settings

- Single Side
- Double Side

Stacker unit

(This display is available only when the device has a stacker unit attached.)

Stacker Unit
= Cartridge

Stacker unit display settings

- Not Cartridge
- Cartridge

Printer unit

(This display is available only when the device has a printer unit attached.)

Printer Unit
= Cartridge

Printer unit display settings

- Not Cartridge
- Cartridge



Barcode unit

(This display is available only when the device has a barcode unit attached.)

Barcode Unit
= Vertical



Barcode unit display

- Not Unit
- Vertical
- Horizontal

5. Keep pressing the  switch until it returns to normal mode, or press the  switch to return to normal mode.



■ Displaying total count



This displays total count in this device.

1. Press the  switch to enter the menu mode.
2. Use the  and  switches to select the following parameters,

D i s p l a y M o d e

and press the  switch.



3. Use the  and  switches to select [Total count] display,
and press the  switch.

4. Use the  and  switches to display the settings.

T o t a l c o u n t

= # # # # # # #

Total count display
00000000~99999999



5. Keep pressing the  switch until it returns to normal mode,
or press the  switch to return to normal mode.

Note)

If when the sheet is left to the hopper the reading operation is discontinued, The actually count and error count is included in the total count because the count is not saved.



■ Displaying serial number



This displays serial number of this device.

1. Press the  switch to enter the menu mode.
2. Use the  and  switches to select the following parameters,

D i s p l a y M o d e



and press the  switch.

3. Use the  and  switches to select [Serial number] display, and press the  switch.

4. Use the  and  switches to display the settings.

S e r i a l n u m b e r
= # # # # # # # #

Serial number display settings
000000000~zzzzzzzzzz

5. Keep pressing the  switch until it returns to normal mode, or press the  switch to return to normal mode.

Operating tests





This section explains operating test procedures.

■ Feed test 1



This test reads the check sheets included in the package to test if the device reads them properly.

If the device doesn't read the check sheets properly, the reading test will stop.



Once reading of the check sheets starts, the test will continue until an error occurs or the hopper is empty.

1. Press the  switch to enter the menu mode.
2. Use the  and  switches to select the following parameters, and press the  switch.

Test Mode



3. Use the  and  switches to select [Feed Test 1].

Feed Test 1
E : 0 , T : 0
Error Count Total Count

4. Press the  switch to confirm the selection and display [Feed Test 1]. ("*" mark flashes in the first column of the first line on the LCD.)
5. Use the  and  switches to select the setting value.

Feed Test 1 = Start

Feed test 1 setting values
• Stop • Start

6. Press the  switch to start/stop feed test 1.
(The flashing "*" mark disappears from the LCD, and the test will start/stop.)
7. Keep pressing the  switch until it returns to normal mode, or press the  switch to return to normal mode.

Note)





- You cannot return to normal mode while the test is running.
- If a reading error occurs on both sides of a sheet, the error count will be two.
- If the stacker unit is installed and an error occurs, paper will be transferred to the selection tray.

■ Feed test 2



This test reads the check sheets included in the package to test if the device reads them properly.

Even if the device doesn't read something properly, the test will continue.

Once reading of the check sheets starts, the test will continue until an error other than a reading occurs or the hopper is empty.

1. Press the  switch to enter the menu mode.
2. Use the  and  switches to select the following parameters, and press the  switch.

T e s t M o d e

3. Use the  and  switches to select [Feed Test 2].

F e e d T e s t 2
 E : 0 , T : 0

Error Count
Total Count



4. Press the  switch to confirm the selection and display [Feed Test 2].
 (“*” mark flashes in the first column of the first line on the LCD.)

5. Use the  and  switches to select the setting value.

F e e d T e s t 2 = S t a r t

Feed test 2 setting values
 • Stop • Start

6. Press the  switch to start/stop feed test 2.
 (The flashing “*” mark disappears from the LCD, and the test will start/stop.)

7. Keep pressing the  switch until it returns to normal mode, or press the  switch to return to normal mode.

Note)

- You cannot return to normal mode while the test is running.
- If a reading error occurs on both sides of a sheet, the error count will be two.
- If the stacker unit is installed and an error occurs, paper will be transferred to the selection tray.

■ Printer test



The test characters is printed on the fed sheet and the sheet will be discharged. (This test will be conducted only when stacker unit and printer unit are installed.)

The number of characters printed varies depending on the printer settings, and character size and interval settings.

Once reading of the check sheets starts, the test will continue until an error occurs or the hopper is empty.



Test characters:

“ ■ !”#\$%&'()*+,-./0123456789:;<=>?@ABCDEFGHIJKLMN O P Q R S T U V W X Y Z [¥] ^ _ 。 「 」 、 ・
ヲ アイ ウ エ オ ヤ ユ ヨ ヅ ツー アイ ウ エ オ カ キ ク ケ コ サ シ ス セ ソ タ チ ツ テ ト ナ ニ ヌ ネ ノ ハ ヒ フ ヘ ホ
マ ミ ム メ モ ヤ ユ ヨ ラ リ ル レ ロ ワ ン ”

1. Press the  switch to enter the menu mode.
2. Use the  and  switches to select the following parameters,

Test Mode



and press the  switch.

3. Use the  and  switches to select [Printer Test].

Printer Test
Count : 0
Count

4. Press the  switch to confirm the selection and display [Printer Test].

(“*” mark flashes in the first column of the first line on the LCD.)

5. Use the  and  switches to select the setting value.

* Printer Test = Start

Printer test setting values
• Stop • Start

6. Press the  switch to start/stop Printer test.
(The flashing “*” mark disappears from the LCD, and the test will start/stop.)

7. Keep pressing the  switch until it returns to normal mode,



or press the  switch to return to normal mode.

Note)

You cannot return to normal mode while the test is running.







■ Printer jet test

This test is done when the printing of sheets is not possible, is not clear. (This test will be conducted only when stacker unit and printer unit are installed.)

1. Press the  switch to enter the menu mode.
2. Use the  and  switches to select the following parameters,

T e s t M o d e

and press the  switch.

3. Use the  and  switches to select [Printer Jet Test].
4. Press the  switch to confirm the selection and display [PJet Test Start = Start].
(“*” mark flashes in the first column of the first line on the LCD.)
5. Press the  switch to do Printer jet test one time.(about 2.5 sec.)
(When Printer jet test ends , the flashing “*” mark disappears from the LCD.)
6. Keep pressing the  switch until it returns to normal mode,
or press the  switch to return to normal mode.

Note)

You cannot return to normal mode while the test is running.

Options

Stacker unit

SR-6500 is equipped with the stacker unit standardly, SR-3500 is equipped with it optionally.

■ Stacker unit specifications (printer)

Printing location	Prints on top surface of fed sheet
Printing method	Inkjet
Number of characters printed	Maximum 72 characters (for A4-size paper)
Kinds of characters printed	Alphabet (uppercase and lowercase letters) Numbers (0 - 9) 36 Symbols (!"# \$% &'()*+,-./:;<=>?@ [¥] ^_ ■ {SP} ~○△□X) ※ 1 Japanese kana (including half and full accents, ◦ 「」, ・ ー)
Character size	Height approximately 3mm x width approximately 3.2mm - 6.4mm
Character interval	Approximately 0.8mm - 92mm
Printing pixels	12 vertical x 9 horizontal pixels
Printing position	2mm or more from standard paper feeding edge to beginning of characters (not extended to timing mark) 2mm or more from right edge of maximum size sheet to beginning of characters
Printing position adjustment	Main scanning direction: Adjust head position manually. Sub scanning direction: Set print starting position command.

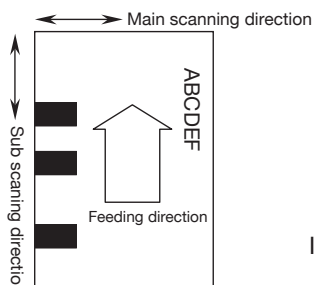

Ink cartridge Expires: 6 months after opening
Life: about 1 million characters ※ 2

The printable area ■ ※ 3

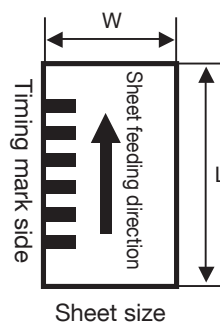
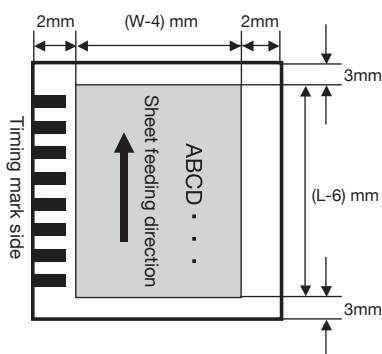

※ 1: ■ in printing letter kind is printed becoming □

※ 2: The number of letters until it stops being printed depend on working condition.

※ 3: The size of printable area depends on the size of the sheet used.

Note)

If a sheet is curled, it may cause a paper jam, so please do not use curly sheet.

■ Stacker unit (printer) preparation

1. Turn the power off and remove the power cord from the outlet.
2. Open the front door of the stacker unit.

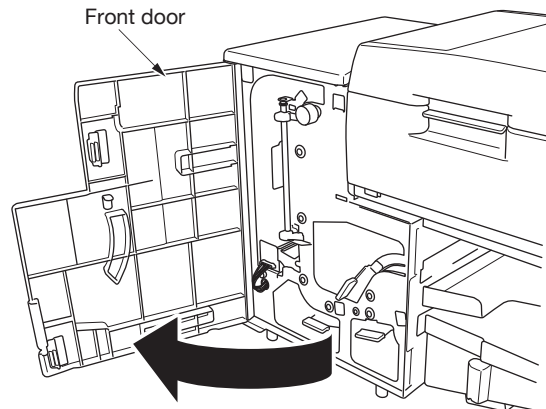

3. Disconnect the printer connector.

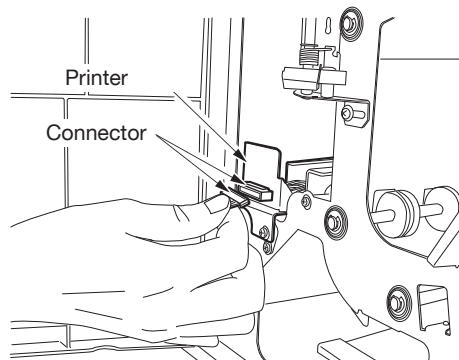

4. Loosen the printer fixing screw to remove it.

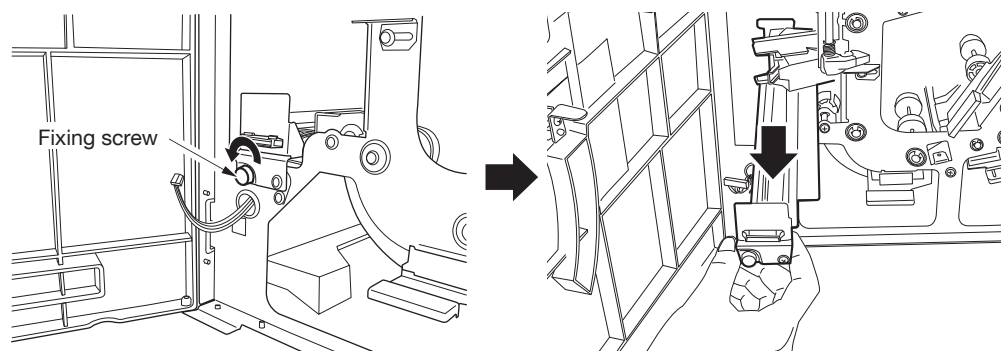

5. Lift the cartridge case lever and insert an ink cartridge.

Note)

Align positioning pins (2 places) of the ink cartridge with the positioning holes (2 places) of the cartridge case.

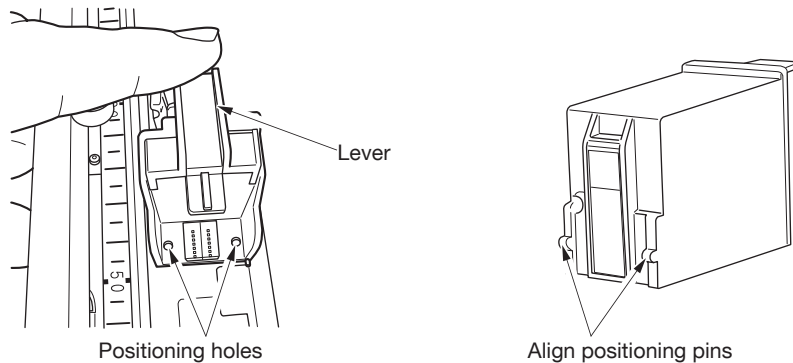

6. Lower the cartridge case lever to lock the ink cartridge.

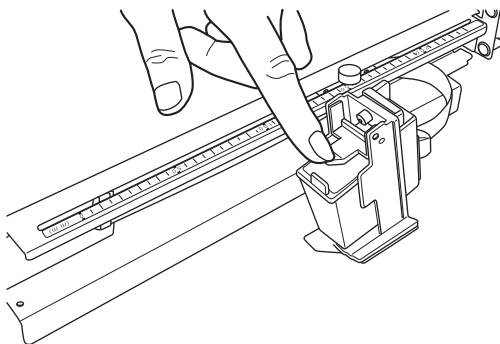

7. Install the printer in the stacker unit.

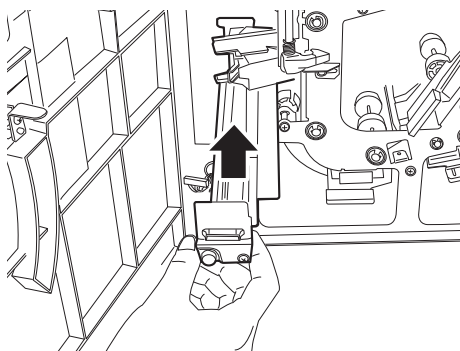

- 8.** Tighten the printer fixing screw and connect the printer connector.

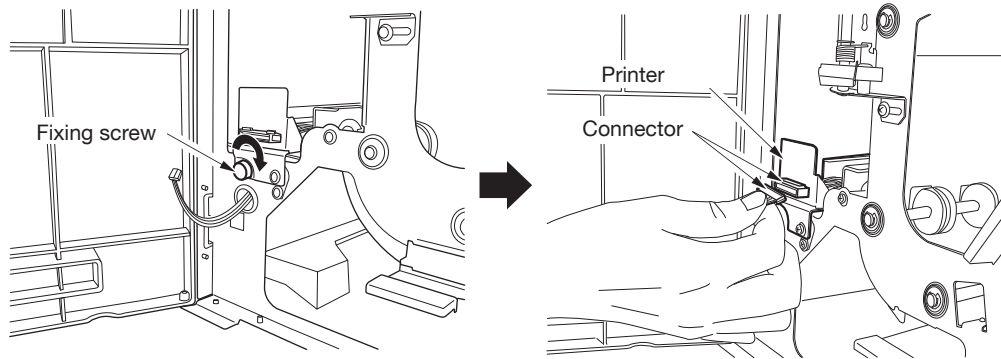

- 9.** Close the front door of the stacker unit.

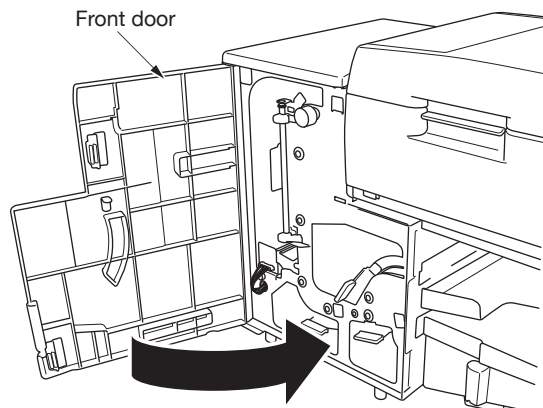

- 10.** Adjust the main tray regulator to the proper paper size.

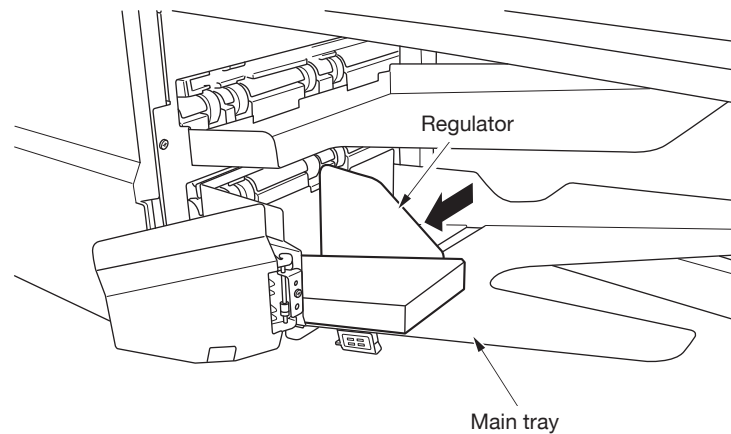

- 11.** Connect the power cord and turn the power on.
12. Set printer control valid (**See** P.53).

■ Printing position adjustment

1. Turn the power off and remove the power cord from the outlet.
2. Open the front door of the stacker unit.

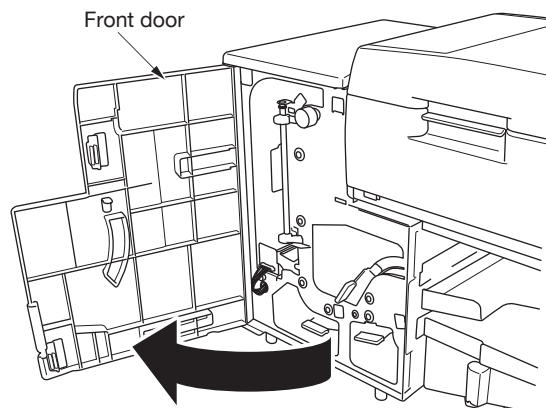

3. Disconnect the printer connector.

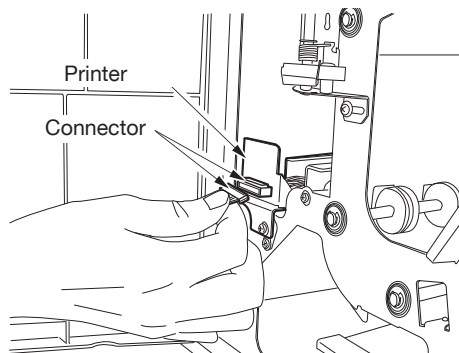

4. Loosen the printer fixing screw to remove it.

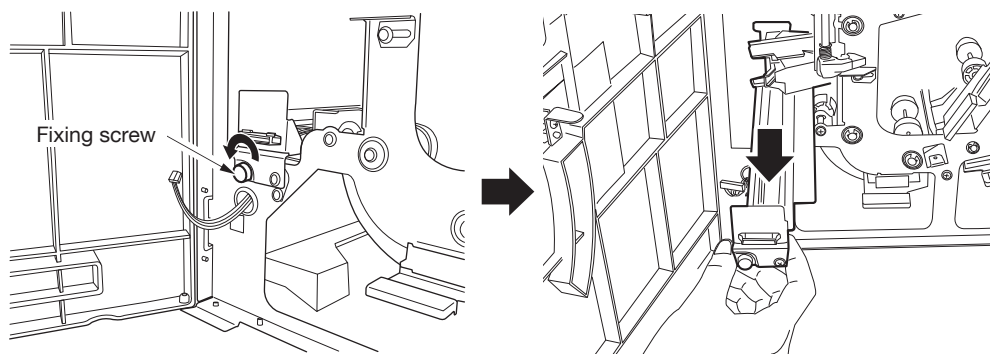

- 5.** Loosen the cartridge case fixing screw, move the cartridge case according to the desired printing position, and tighten the screw to secure it.
* The scale on the positioning sticker indicates the printing position from the edge of the paper. The printing position is determined by aligning the cartridge case fixing screw with the scale on the sticker.

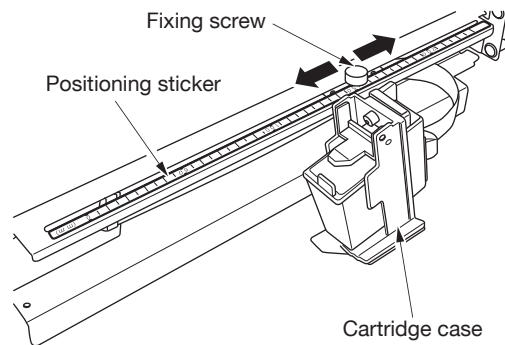

- 6.** If the printing position is properly aligned, install the printer in the stacker unit.

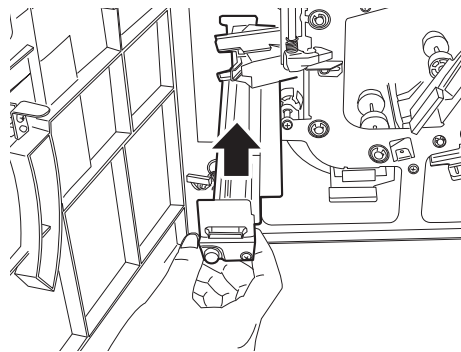

- 7.** Tighten the printer fixing screw and connect the printer connector.

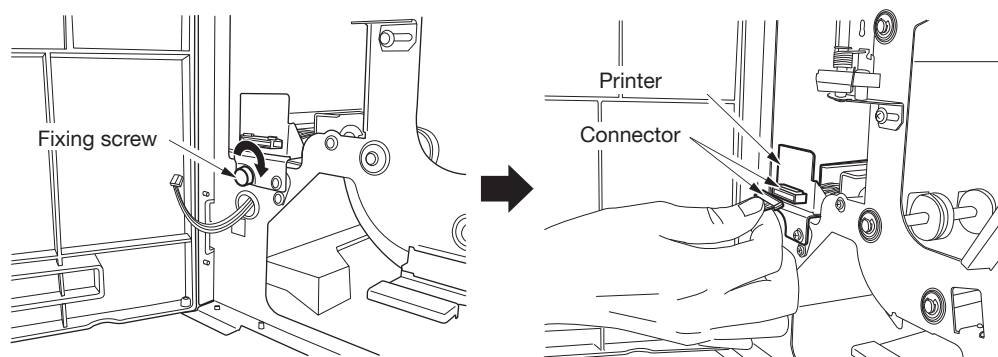

- 8.** Close the front door of the stacker unit.

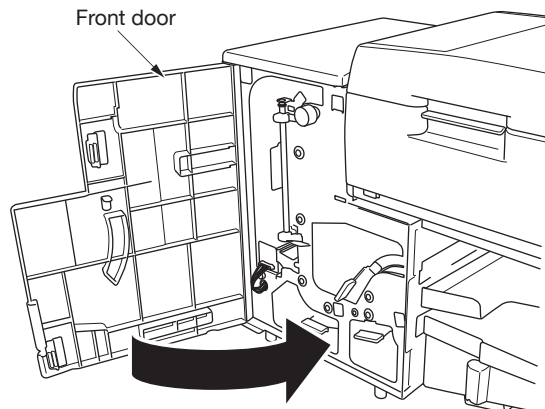

- 9.** Connect the power cord and turn the power on.

- 10.** Execute printer test (**See** P.72).

* If the printing position is misaligned, adjust it.

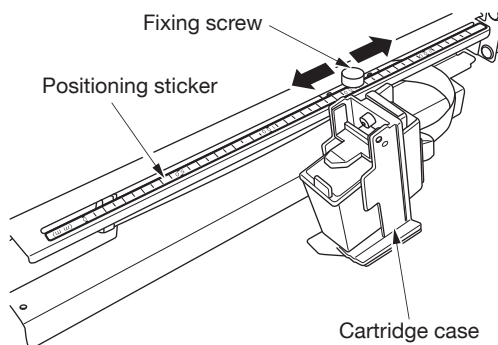

■ Clearing paper jams

1. Open the front door of the stacker unit.

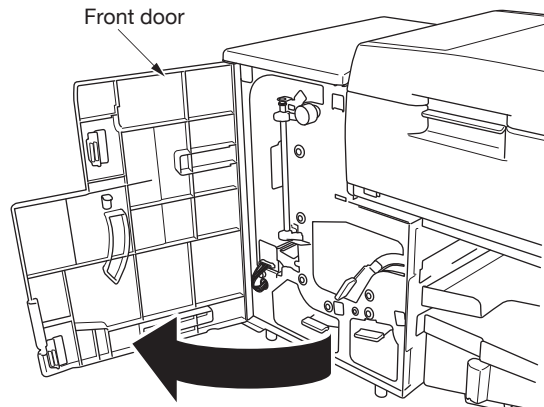

2. Open the jam release levers (4 levers) or turn the jam-removing knob to remove jammed paper.

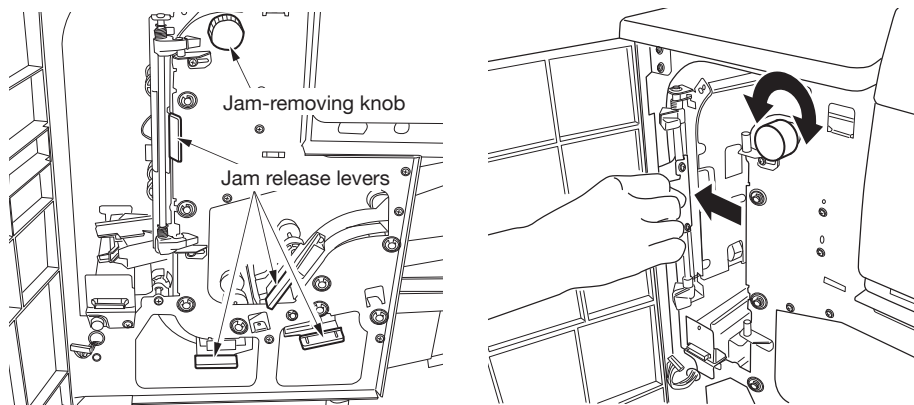

3. After removing jammed paper, close the jam release levers.

4. Close the front door of the stacker unit.

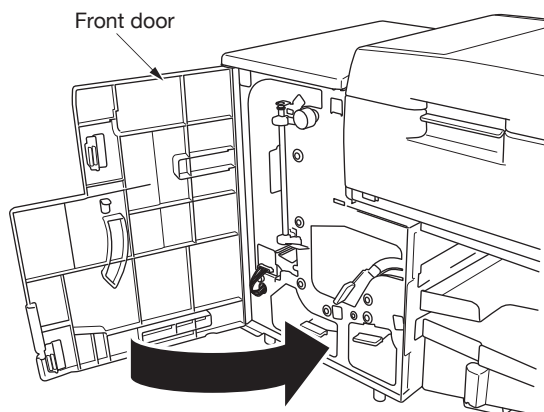

■ Stacker unit precautions for use

- (1) Make sure to tightly close the jam release levers and the front door. Loose levers or a loose door may trigger paper jams.
- (2) Use ink cartridges before their expiry dates.
- (3) Under the following conditions, remove the ink cartridge from the device, and store it at room temperature (10-35°C) in the ink cartridge storage bag included in the package.
 - If the main device is stored in an environment outside operating condition parameters.
 - If the printer will not be used for a long time (about 1 week or more).
- (4) Under the following conditions, defective printing (cannot print, streaked printing) may occur.
 - Ink cartridge is stored in environments outside of operating conditions.
 - The printer unit is left installed in the main device and is not used for a long time (about 1 week or more).

If you have printing problems, you can try to fix them by conducting a printer jet test.
If the problem doesn't improve, the ink head may be dirty.
Remove the ink cartridge and clean the ink head.

Cleaning method:

Wet a napless (low nap) cloth, tissue paper, or other similar item (tissue hereinafter) with water.

Apply the wet tissue to the ink head for several seconds.

Gently wipe the ink head.

If there is any ink left on the ink head, gently wipe it off with a dry tissue.

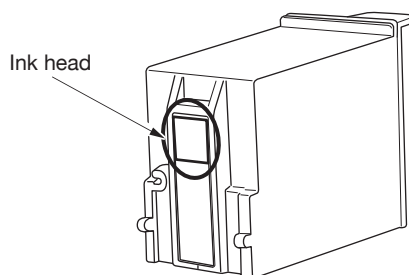

- (5) This device consumes the ink little by little even when it does not print. Because it conducts extra injection automatically to prevent clogging up of ink cartridge. If you do not use the printer function, set printer control the invalid and then remove the ink cartridge and keep. And cutting down on consuming the ink becomes possible.
- (6) When you do not use the printer, move the case of cartridge to almost central position of the width of the sheet you use. So It is possible to lighten the occurrence of jam.

Back side reading unit

If you install a back side reading unit in the device, both sides of a sheet can be read.
When installing the back side reading unit, set the reading side settings at the same time.



“Data reading settings ■ Setting reading side” in this manual. P.38

Please see the following pages regarding confirmation of settings.



“Displaying various information

■ Displaying the version” in this manual. P.64

“Displaying various information

■ Displaying back side reading sensor settings” in this manual. P.66

“Displaying various information

■ Displaying optional unit settings” in this manual. P.67

Printer unit

Printer unit is a optional equipment with SR-3500.

■ Printer unit specifications

Printing location	Prints on top surface of fed sheet
Printing method	Inkjet
Number of characters printed	Maximum 72 characters
Kinds of characters printed	Alphabet (uppercase and lowercase letters) Numbers (0 - 9) 36 Symbols (!"# \$% &'()*+,-./:;<=>?@ [¥] ^_ ■ {SP} ~○△□×) Japanese kana (including half and full accents, ◦ 「」、・ー)
Character size	Height approximately 3mm x width approximately 3.2mm - 6.4mm
Character interval	Approximately 0.8mm - 92mm
Printing pixels	12 vertical x 9 horizontal pixels
Printing position	2mm or more from standard paper feeding edge to beginning of characters 2mm or more from right edge of maximum size sheet to beginning of characters

Printing position adjustment

Main scanning direction: Adjust head position manually.

Sub scanning direction: Set print starting position command.

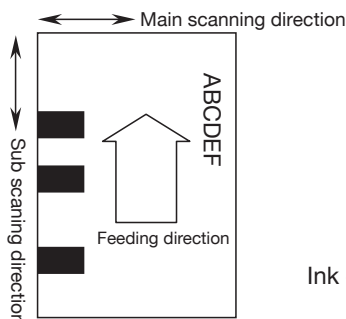

Ink cartridge Expires: 6 months after opening
Life: about 1 million characters ※ 1

■ Pritable area

Please note the printable area differs depending on the printing method.

The printable area is indicated in □ of the following figure depending on the size of the sheet used. ※ 2

Note)

If a sheet is curled, it may cause a paper jam, so please do not use curly sheet.

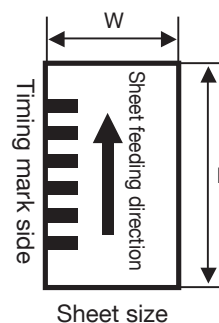

1. Printing after reading marks

The printable area is a maximum of 230mm from the bottom edge of a sheet.

[When sheet size is $(L > 233)$ mm]

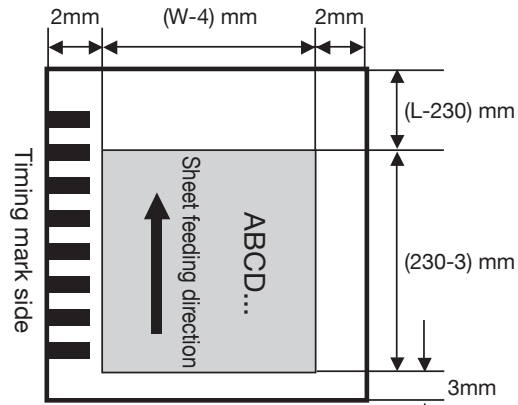

[When sheet size is $(L \leq 233)$ mm]

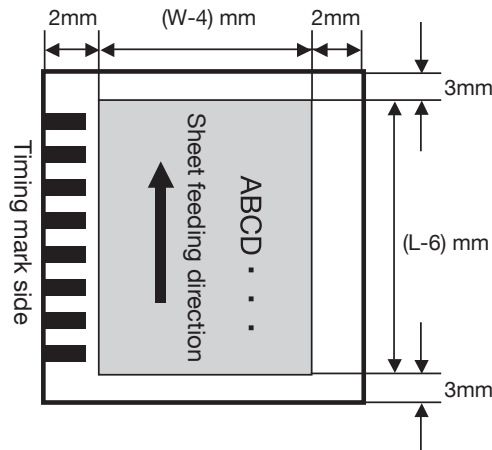

2. Printing while reading marks at the same time

The overall area can be printed regardless of the sheet size.

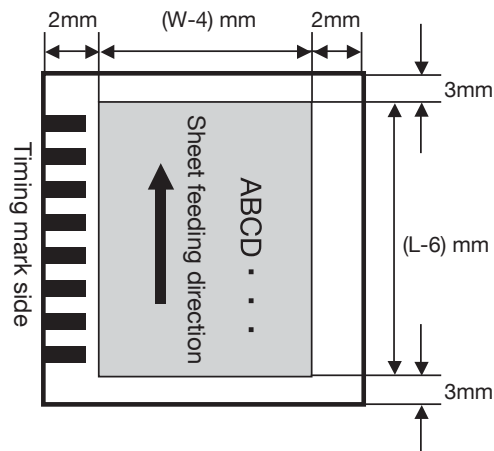

※ 1: The number of characters until it stops being printed depend on working condition.

※ 2: The size of printable area depends on the size of the sheet used.

■ Printer unit preparation

1. Turn the power off and remove the power cord from the outlet.
2. Remove the carrier cover.

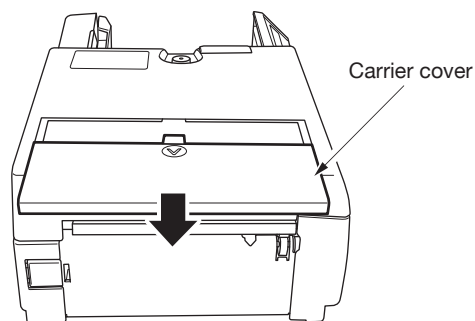

3. Lift the cartridge case lever and insert an ink cartridge.

Note)

Align positioning pins (2 places) of the ink cartridge with the positioning holes (2 places) of the cartridge case.

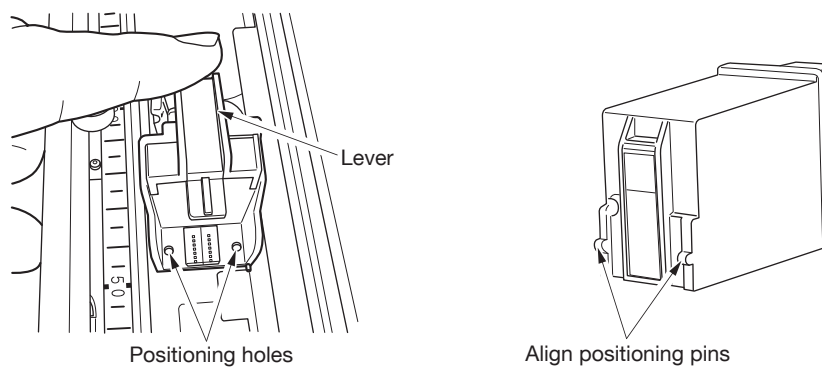

4. Lower the cartridge case lever to lock the ink cartridge.

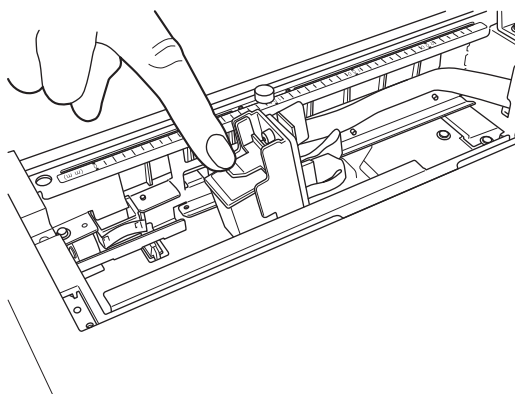

■ Printing position adjustment

1. Turn the power off and remove the power cord from the outlet.
2. Remove the carrier cover.

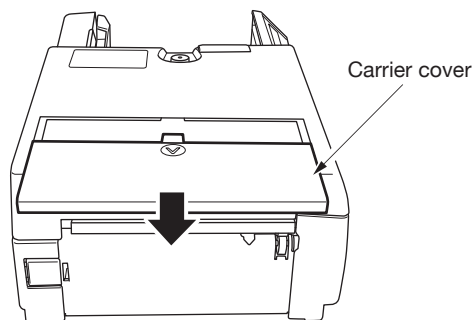

3. Loosen the cartridge case fixing screw, move the cartridge case according to the desired printing position, and tighten the screw to secure it.
* The scale on the positioning sticker indicates the printing position from the edge of the paper. The printing position is determined by aligning the cartridge case fixing screw with the scale on the sticker.

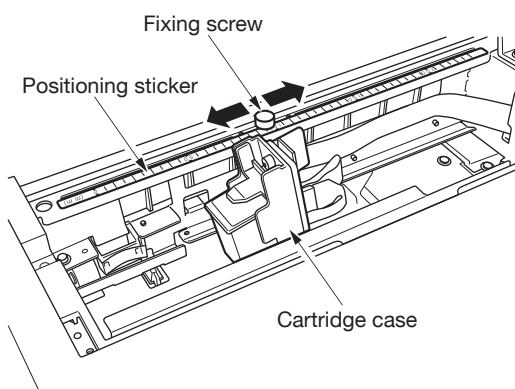

4. Connect the power cord and turn the power on.
5. Set printer control valied (**See** P.53).

6. Execute printer test (**See** P.72).

* If the printing position is misaligned, loosen the cartridge case fixing screw, adjust the cartridge case according to desired printing position, and tighten the screw to secure it.

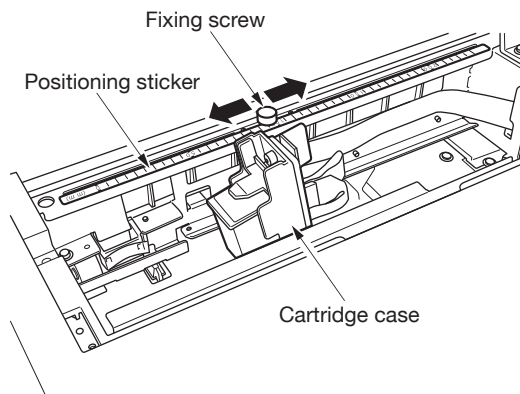
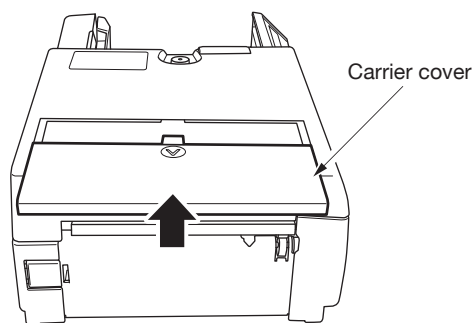
**7.** If the printing position is properly aligned, close the carrier cover.**Note)**

If the cartridge case is difficult to move, grasp it by the top part of the case.

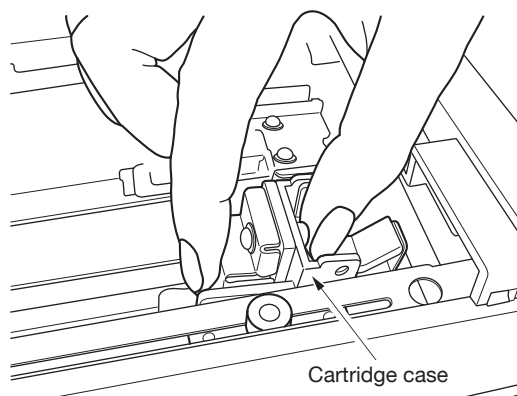

■ Printer unit precautions for use

- (1) Use ink cartridges before their expiry dates.
- (2) Under the following conditions, remove the ink cartridge from the device, and store it at room temperature (10-35°C) in the ink cartridge storage bag included in the package.
 - If the main device is stored in an environment outside operating condition parameters.
 - If the printer will not be used for a long time (about 1 week or more).
- (3) Under the following conditions, defective printing (cannot print, streaked printing) may occur.
 - Ink cartridge is stored in environments outside of operating conditions.
 - The printer unit is left installed in the main device and is not used for a long time (about 1 week or more).

If you have printing problems, you can try to fix them by conducting a printer Jet test.

If the problem doesn't improve, the ink head may be dirty.

Remove the ink cartridge and clean the ink head.

Cleaning method:

Wet a napless (low nap) cloth, tissue paper, or other similar item (tissue hereinafter) with water.

Apply the wet tissue to the ink head for several seconds.

Gently wipe the ink head.

If there is any ink left on the ink head, gently wipe it off with a dry tissue.

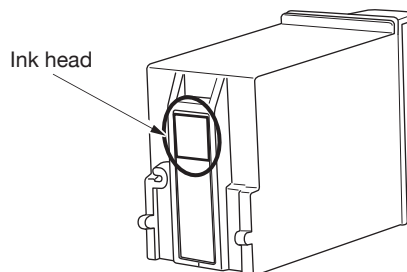

- (4) Always turn the power off when exchanging ink cartridge because it can cause trouble.
- (5) This device consumes the ink little by little even when it does not print. Because it conducts extra injection automatically to prevent clogging up of ink cartridge. If you do not use the printer function, set printer control the invalid and then remove the ink cartridge and keep. And cutting down on consuming the ink becomes possible.

Barcode unit / V • barcode unit / H

If you install a barcode unit in the device, barcodes on paper can be read.

■ Barcode unit specifications

Barcode unit / V (vertical feeding)

Reading direction	Vertical feeding (bars are parallel to sheet feeding direction)
Codes	JAN/EAN/UPC (module 0.33 mm, 0.8 times~ 2 times) NW-7 CODE-39 CODE-128 ITF Industrial 2 of 5 COOP 2 of 5 * The unit can be set to read up to four kinds of codes.
Reading area	Sheet feeding direction: 10mm from the front edge of a sheet to 10mm from the rear edge of a sheet Paper width direction: ± 30 mm of 50-200mm from standard paper feeding edge.
Number of digits to be read	Maximum 32 digits (total number of digits to be read is 150 or less) (For CODE-128, a maximum of 64 digits if the starting character is CODE-C)
Number of labels to be read	Maximum 10 (1 sheet)
Label interval	15mm or more
Barcode printing specifications	<ul style="list-style-type: none"> • Length 60mm or less X height 10mm or more (For narrow bars with widths of 0.19mm or less, use coated labels less than 40mm long ※ 1) * Barcode length requires a quiet zone (margin) more than 2.54mm on both sides or 10 times the width of the narrow bar, whichever is bigger. • PCS: 0.7 or more (light-source wavelength: 633nm) • Bar width (narrow bar) 0.125-1mm * Bar:space ratio = 1:0.85-1.15 * Recommended N:W ratio = 1:2.5 * There should not be any bleeding, chipping, blank areas, etc. • Skew: ± 5 degrees or less from the standard paper feeding edge. * If narrow bar width is 0.19mm or less, ± 2 degrees or less.
Reading side	Read the top surface of a sheet as it is fed
Directions to adjust reading positions	Paper width direction: manually adjust the head position Sheet feeding direction: <ul style="list-style-type: none"> “Specifying reading start position mode” Use command to specify reading starting position from the front edge of a sheet and reading width for number of barcodes. “Whole area reading mode” Entire area of a sheet can be read. (Barcodes in all areas of the sheet-feeding direction can be read.) ※ 1 entire thickness of label sticking section is 0.25mm or less Label must not be floated and come off.

Barcode unit / H (horizontal feeding)

Reading direction	Horizontal feeding (bar direction is perpendicular to sheet feeding direction)
Codes	JAN/EAN/UPC (module 0.33 mm, 0.8 times~ 2 times) NW-7 ITF CODE-39 CODE-93 CODE-128 EAN-128
Reading area	Sheet feeding direction: 12mm from the front edge of a sheet to 65mm from the rear edge of a sheet Paper width direction: 20mm from timing mark size to 224mm (centered on the sensor)
Number of digits to be read	Maximum 48 digits
Number of labels to be read	Maximum 10 (total number of digits to be read is 200 or less)
Label interval	40mm or more
Barcode printing specifications	<ul style="list-style-type: none"> • Height 10mm or more <ul style="list-style-type: none"> * It requires a starting margin of 12mm or more, and an ending margin of 4 characters or more for a barcode. • PCS: 0.7 or more • Bar width (narrow bar) 0.125-2mm <ul style="list-style-type: none"> * Bar:space ratio = 1:0.85-1.15 * Recommended N:W ratio = 1:2.5 * There should not be any bleeding, chipping, blank areas, etc. • Skew: ± 3 degree or less from the standard paper feeding edge. • Sticking label: ※ 1
Reading side	Read the top surface of a sheet as it is fed
Directions to adjust reading positions	Paper width direction: manually adjust the head position Sheet feeding direction: <ul style="list-style-type: none"> “Specifying reading start position mode” Use command to specify reading starting position from the front edge of a sheet (measurement: mm) and reading area for number of barcodes. “Whole area reading mode” Entire area of a sheet can be read. (Barcodes in all areas of the sheet-feeding direction can be read.) “SR9000 compatible mode” Specify barcode reading starting position using timing mark ※1 entire thickness of label sticking section is 0.25mm or less Label must not be floated and come off.

■ Barcode readable area

The barcode readable area differs depending on the kind of barcode unit.

1. Barcode unit / V (vertical feeding)

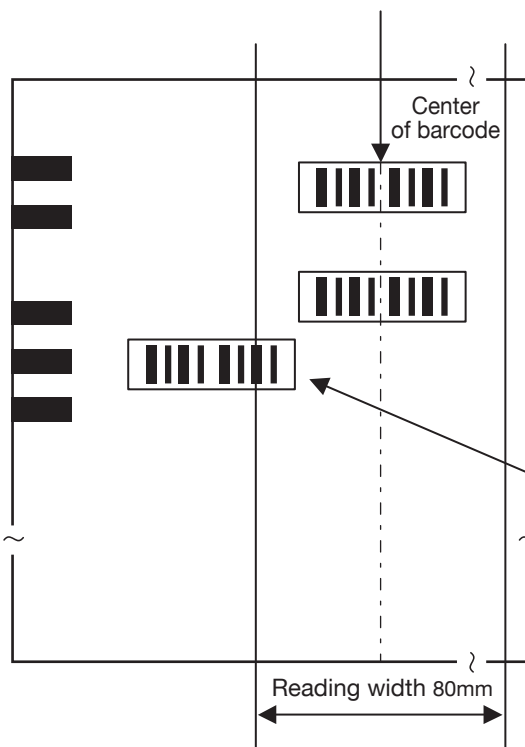
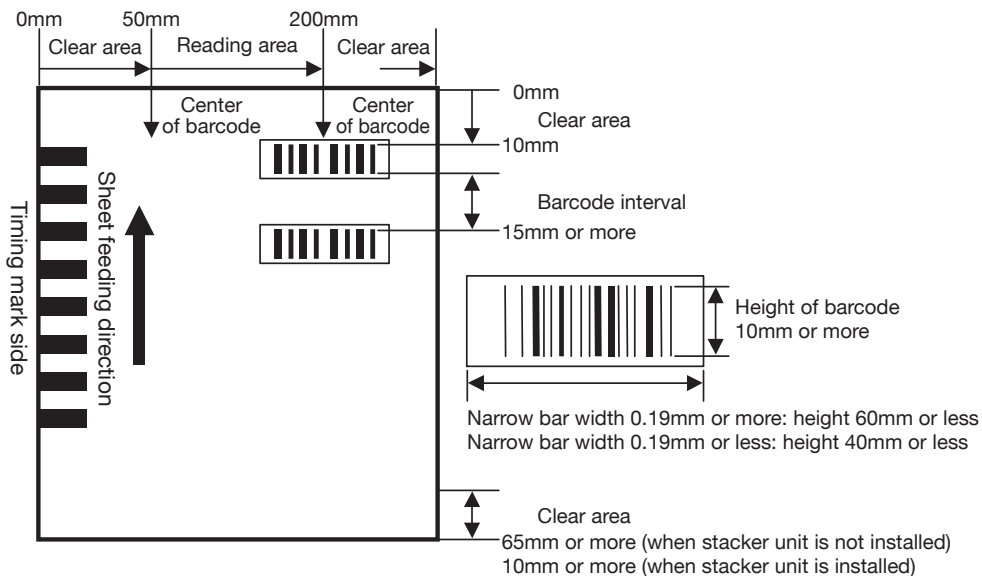

Note)
Adjust the barcode center when reading a number of sheets .In addition when it makes the barcode adjoin which is not read, do not make it go into reading area.

2. Barcode unit / H (horizontal feeding)

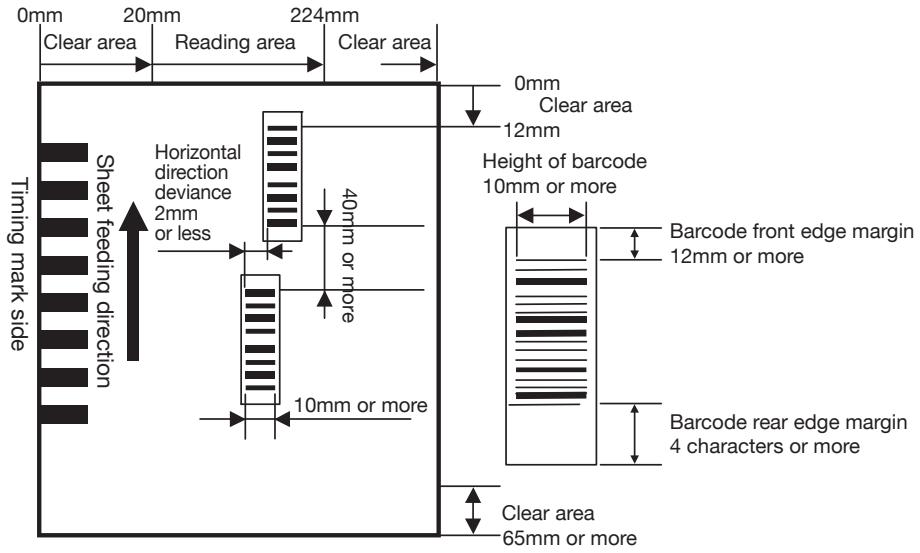

■ Barcode reading position adjustment

1. Turn the power off.
2. Remove the carrier cover.

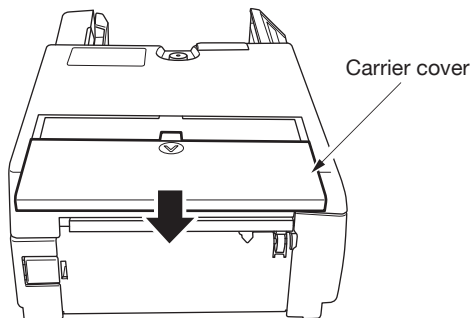

3. Loosen the barcode unit position fixing screw, move the barcode unit according to barcode position, and tighten the screw to secure it.

* The scale on the positioning sticker indicates center of the barcode position from the edge of the paper (Timing mark side). The barcode position is determined by aligning the barcode unit position fixing screw with the scale on the sticker.

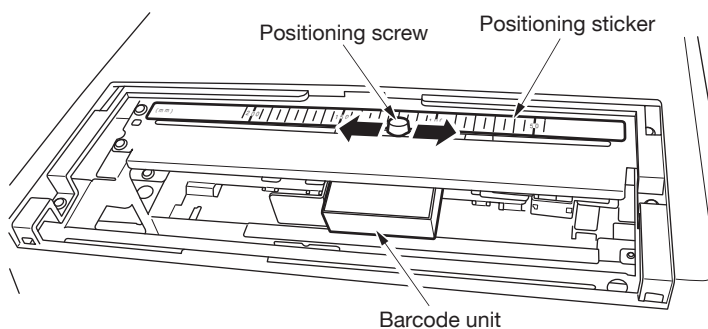

4. Turn the power on.

- 5.** check reading using a diagnostic utility.
* If a reading error occurs, the barcode reading position may be misaligned, so make an adjustment.

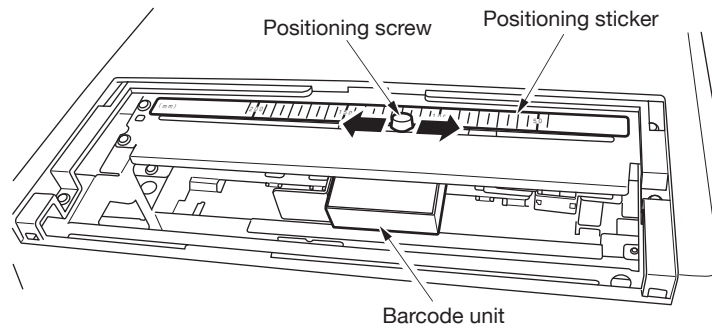

- 6.** If the barcode reading position is properly aligned, close the carrier cover.

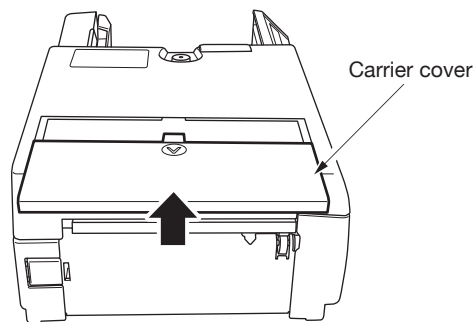

■ Barcode unit precautions for use

- (1) When applying barcode stickers, etc. on a sheet, make sure that sheet thickness with stickers is 0.25mm or less.
- (2) When applying barcode stickers, etc. on a sheet, avoid the grayed area below.

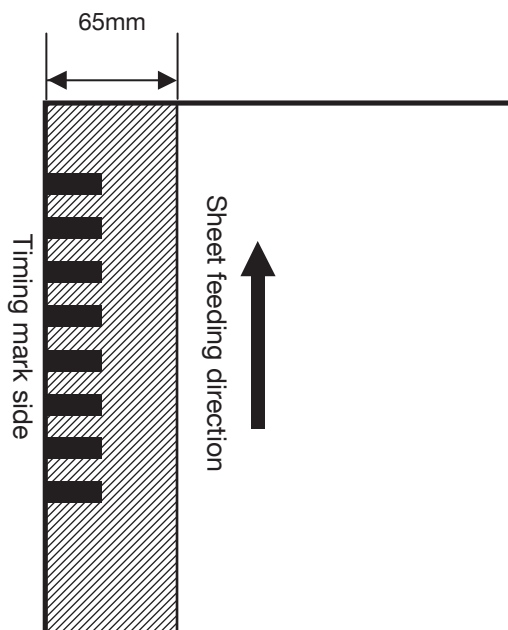

- (3) Make barcodes according to the following specifications and guidelines.
 - AIM USS (Automatic Identification Manufacturers barcode symbol specifications)
 - JIS
 - JIS X 0501 Barcode symbols for common product codes
 - JIS X 0502 Barcode symbols for logistic product codes
 - JIS X 0503 Barcode symbol NW-7 and code 39 basic specifications
- (4) Faded, chipped, and bleeding barcodes cannot be read. Please note that barcodes printed with low-resolution printers such as dot-matrix printers and inkjet printers tend to have similar results.
- (5) If the sensor area becomes dirty with paper powder, use a soft cloth, a cotton swab, or similar materials soaked with plastic cleaner, or use a cloth for glasses to wipe it.

Cleaning

Dirty rollers, reading lenses, and sensors can cause various operational errors. Clean them regularly using the following procedures. Cleaning intervals differ depending on usage conditions (usage frequency, quality of paper used, etc.) Cleaning periods are for your reference -- clean the device soon if you notice dirt or other irregularities.

Note)

Always turn the power off when cleaning.

- (1) **Cleaning rollers**
After feeding 5,000 sheets, a large number of cards, or when using carbon paper, wipe the rollers softly with a clean cloth slightly wetted with disinfectant alcohol (ethanol).
* If the rollers are stained, the stains may rub off on cards or other various malfunctions may occur.
- (2) **Cleaning reading lens**
Clean the reader lens by softly wiping it with a clean cloth slightly wetted with disinfectant alcohol (ethanol) once a month or every 5,000 sheets.
* If the reading lens is stained, reading errors may occur.
- (3) **Cleaning various sensors**
Softly wipe the sensors with a clean cloth slightly wetted with disinfectant alcohol (ethanol) once a month or every 5,000 sheets.
Use air blow etc. when cleaning the left skew sensor section.
* If the sensors are stained (with paper powder, etc.) detection errors may occur.

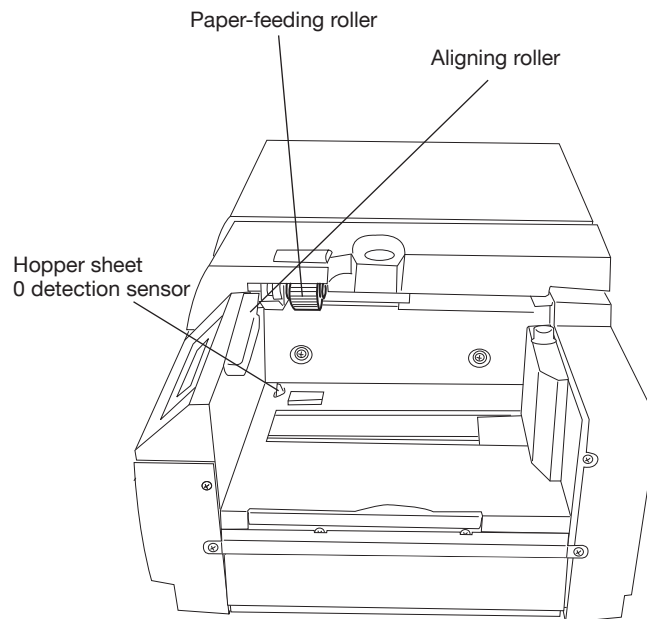

OPTICAL MARK READER SR-3500/SR-6500
Cleaning

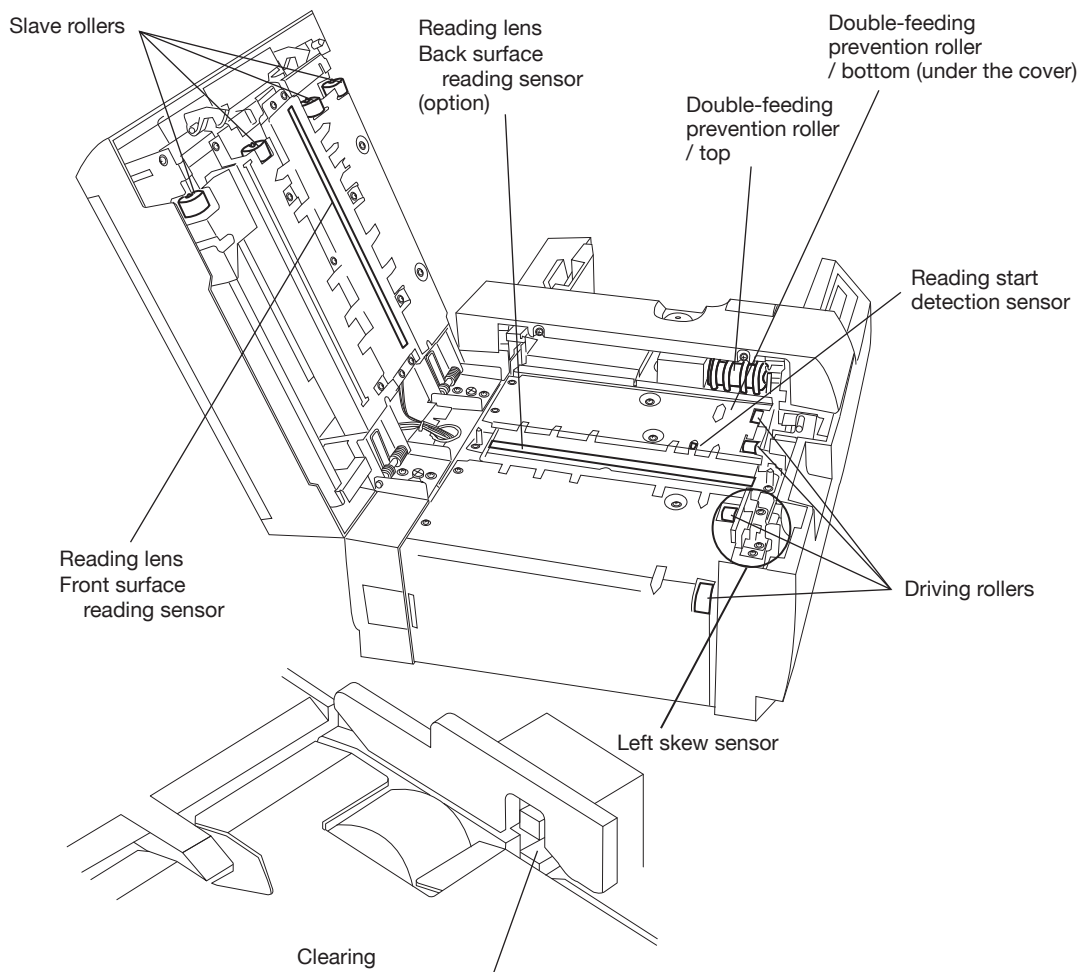

Stacker unit (when stacker unit is installed)

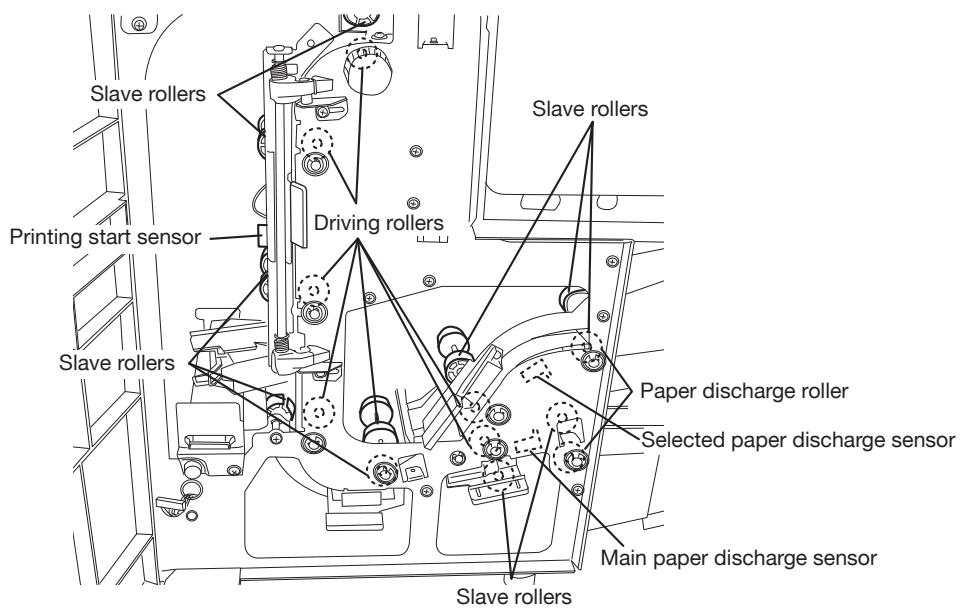

■ Cleaning procedures

Main body unit

1. Turn the power off and remove the power cord from the outlet.
2. Grasp the lock lever to release the lock, and push the top cover up to open it.

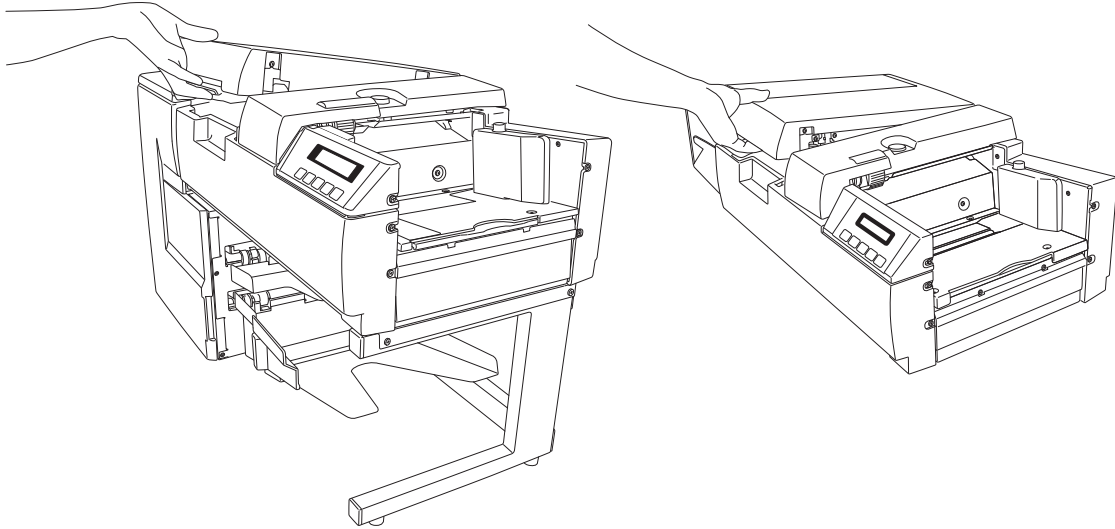

3. Remove the stopper. (1 screw)
4. Clean necessary parts.
5. Install the stopper. (1 screw)

⚠ Warning

If there is no stopper installed, fingers and other body parts could be pinched and injured by the back hinge.

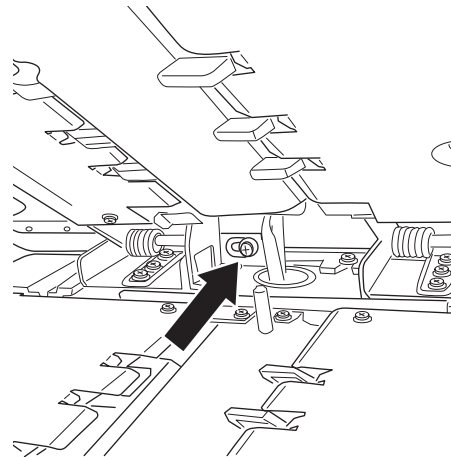

6. Close the top cover.
Slowly close the top cover and press it until there is a click sound that indicates it is locked.

Stacker unit (when stacker unit is installed)

1. Turn the power off and remove the power cord from the outlet.
2. Open the front door of the stacker unit.

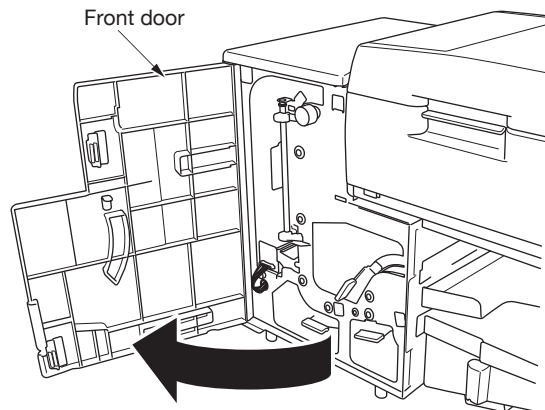

3. Open the jam release lever.

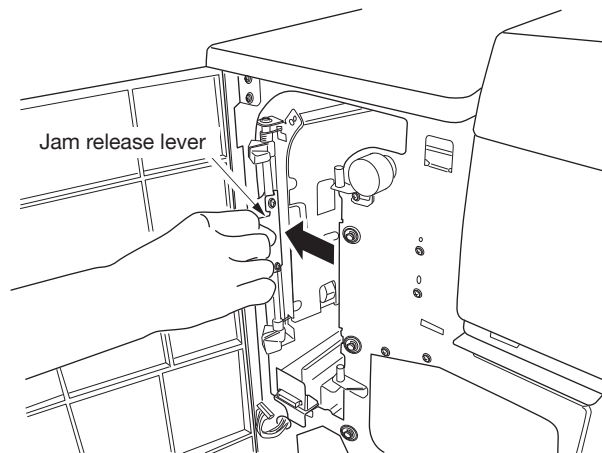

4. Clean necessary parts.

- 5.** Close the jam release lever.

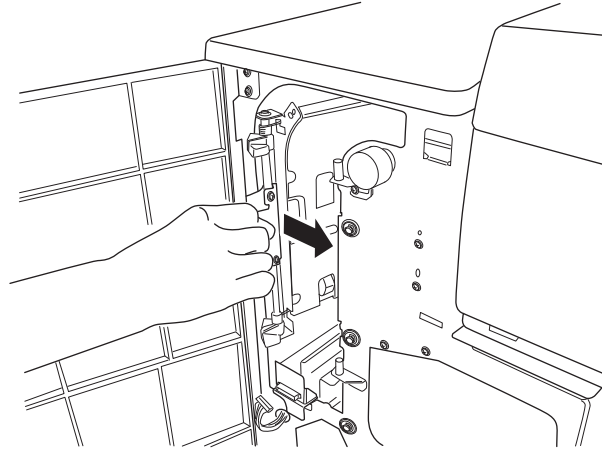

- 6.** Clean the remaining three parts in the same manner as in steps 3 to 5.

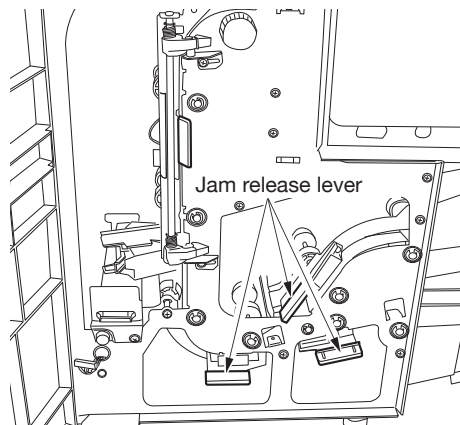

- 7.** Close the front door of the stacker unit.

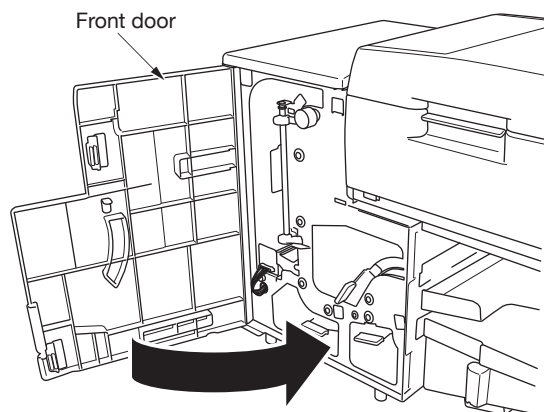

Service schedule

For stable operation of this device, regular replacement of components is required. See the following table, and contact us, or the store where you purchased the device, when requiring component replacement.

Main body unit

Component name	Number	Replacement reference (counter number)	Remarks
Paper-feeding roller	1	100,000 or 3 years	-
Double-feeding prevention roller / top	1	100,000 or 3 years	Replace at the same time as double-feeding prevention roller / bottom
Double-feeding prevention roller / bottom	1	100,000 or 3 years	Replace at the same time as double-feeding prevention roller / top
Aligning roller	1	100,000 or 3 years	-
Driving roller / A	4	500,000 or 3 years	-

* Replacement periods may differ depending on usage conditions (usage frequency, quality of paper used, etc.)

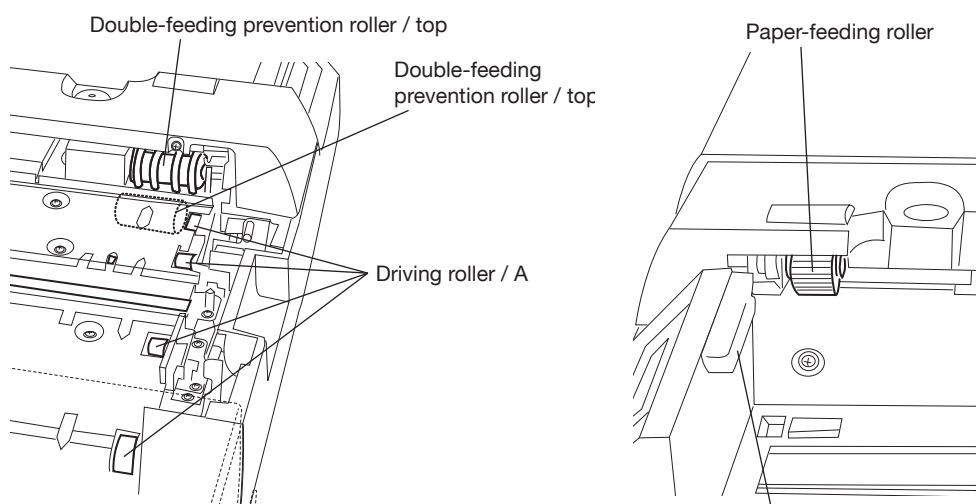

Stacker unit (when stacker unit is installed)

Component name	Number	Replacement reference (counter number)	Remarks
Driving roller / 1	1	500,000 or 3 years	-
Driving roller / 2	2	500,000 or 3 years	-
Driving roller / 3	2	500,000 or 3 years	-
Driving roller / 4	1	500,000 or 3 years	-
Driving roller / 5	1	500,000 or 3 years	-
Paper exit roller / 1	2	500,000 or 3 years	-

* Replacement periods may differ depending on usage conditions (usage frequency, quality of paper used, etc.)

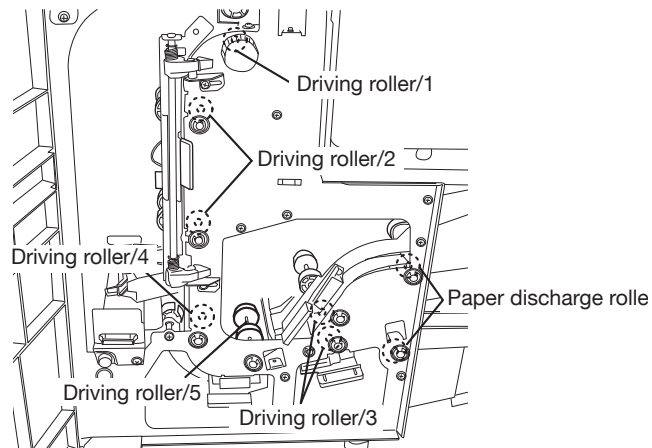

External diagram(SR-3500)

(Unit : mm)

Front view

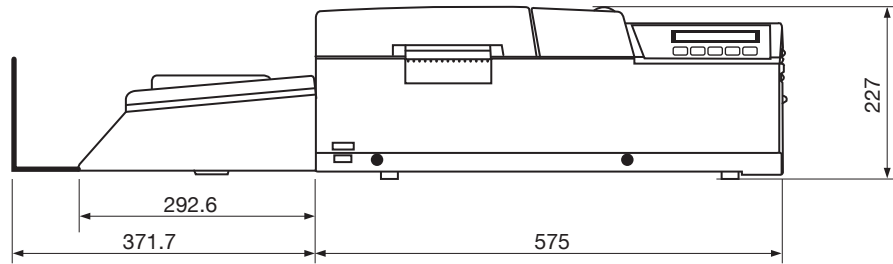

Top view

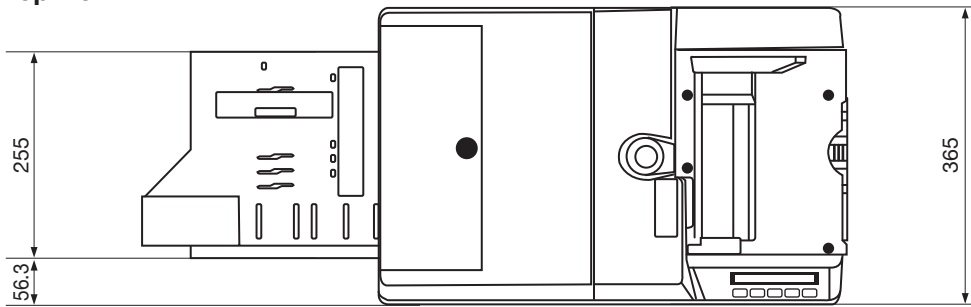

Rear view

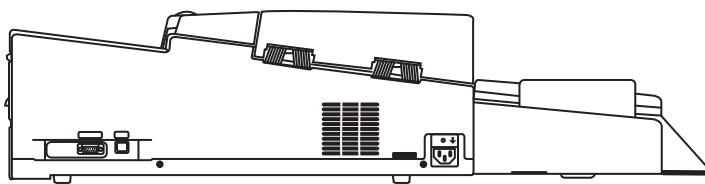

Left view

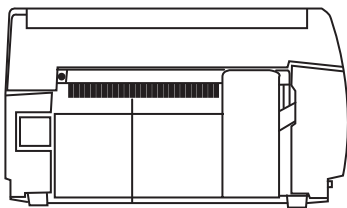

Right view

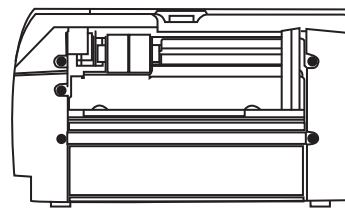

External diagram (SR-6500,SR-3500 when stacker unit is installed)

(Unit : mm)

Front view

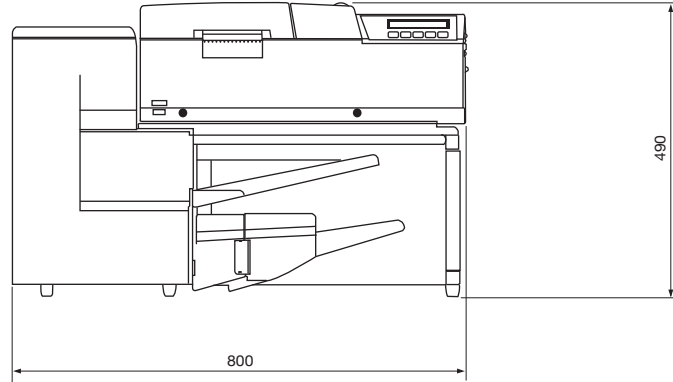

Top view

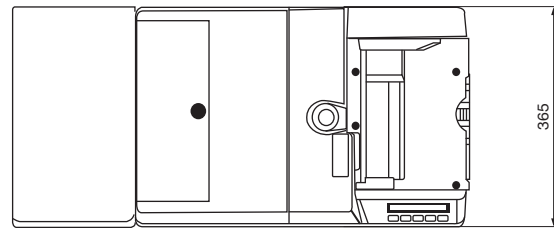

Rear view

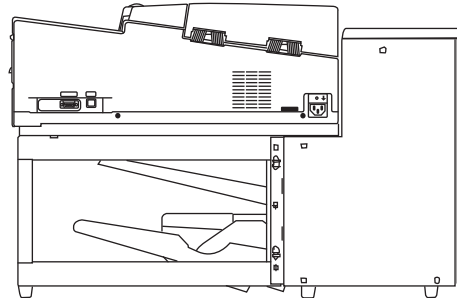

Left view

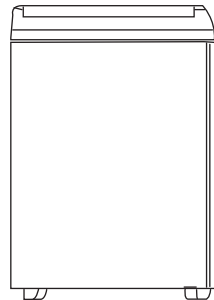

Right view

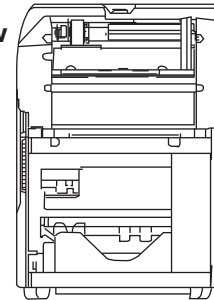

List of menu modes

Setting menu	Setting item	Setting value		
Operation Mode		SR-3500 mode , SR-600 mode SR-6500 mode , SR-9000 mode	*1	*2
Setting of Interface	Device ID	0 - 126	O	×
	Baud Rate	9600 , 19200 , 38400 , 57600 , 115200	×	O
	Character Bit Length	7 , 8	×	O
	Parity	None , Odd , Even	×	O
	Stop Bit	1 , 2	×	O
	Flow Control	RS/CS , Xon/Xoff , None	×	O
	Character Code	Accept All , Ignore 4 Codes	×	O
Setting of Reading	Setting of Column	1 - (maximum) Columns *3	O	O
	Reading Method	Control fore , Control back, Direct , FACOM, Mark to mark Mark to mark *5	O	O
	Magnification (display only when timing control types are selected)	1 - 3 - 9 times (for top-end timing control) 2 - 3 - 9 times (for bottom-end timing control)	O	O
	Min. Density Level	1 - 4 - 16	×	O
	Density Balance	1 - 15	×	O
	Reading Side (only when back-sided reading unit is installed)	Single Side , Double Side	O	O
	Hopper Mode (displayed only when manual paper feeding mode is selected)	ADF , Manual Fee	O	O
	Wait Time for Form	None , 1 - 10 - 99s	O	O
	Paper Weight	Automatic, 84g/m ² , 105g/m ² , 128g/m ² , 157g/m ²	O	O
	Paper hold	Not Use , Use	×	O
Setting of Error Detection	Automatic Paper Discharge	Yes , No	O	×
	Sheet Empty Detection	No , Yes	O	×
	Timing Mark Error Detection	Yes , No	O	×
	Double-Feeding Detection	Yes , No	O	O
	Left End Skew Detection	Yes , No	O	O
Setting of Buzzer	Buzzer Control	Valid , Invalid	O	O
	Buzzer Sound Adjustment (displayed only when it's valid)	1 - 3 - 5	O	O
Setting of Stacker (only when the stacker unit is installed)	Go Out Direction	Main , Select	×	O

Setting menu	Setting item	Setting value	*1	*2	
Setting of Printer (only when the stacker unit and the printer unit are installed)	Printer Control	Valid , <u>Invalid</u>	○	○	
	Size	<u>3.2mm</u> - 96.0mm , 0.8Pitch	○	×	
		<u>3.2mm</u> , 4.0mm, 4.8mm, 5.6mm, 6.4mm	×	○	
	Magnification	<u>1 Time</u> - 15 Time	×	○	
	Character Pitch	<u>0.8mm</u> - 92.0mm , 0.1Pitch	○	×	
<u>0 Dot</u> - 99 Dots		×	○		
Setting of Barcode (only when the barcode unit is installed)	Barcode Control	<u>Valid</u> , Invalid	○	×	
Setting of Electric Power	Time for Power Save	None , 1 Minute - <u>5 Minutes</u> - 60 Minutes	○	○	
	Time for Standby	None , 1 Minute - <u>5 Minutes</u> - 60 Minutes	○	○	
Display Mode	Display Info	Main Body Unit (01 - zz)	*4	○	○
		Front Reading Unit (01 - zz)	*4	○	○
		Back Reading Unit (only when back-sided reading unit is installed) (01 - zz)	*4	○	○
		Stacker Unit (only when the stacker unit is installed) (01 - zz)	*4	○	○
		Printer Unit (only when the printer unit is installed) (01 - zz)	*4	○	○
		Barcode Unit (only when the barcode unit is installed) (01 - zz)	*4	○	○
	Type of front Reading Sensor	Sensor Pitch (1/6 , 0.2 , 0.25 , 0.3 inch)	*4	○	○
		Sensor of Type (Infra Red , Visible Red)	*4	○	○
	Type of Back Reading Sensor (Displayd only for back-side unit)	Sensor Pitch (1/6 , 0.2 , 0.25 , 0.3 inch)	*4	○	○
		Sensor of Type (Infra Red , Visible Red)	*4	○	○
	Type of Option	Reading Sensor Unit (Single Side , Double Side)	*4	○	○
		Stacker Unit (only when the stacker unit is installed) (Not Cartridge , Cartridge)	*4	○	○
		Printer Unit (only when the printer unit is installed) (Not Cartridge , Cartridge)	*4		
		Barcode Unit (only when the barcode unit is installed) (Not Unit , Vertical , Horizontal)	*4	○	○
	Total count	(00000000 - 99999999)		○	○
	Serial number	(00000000 - zzzzzzzzz)		○	○

List of menu modes

Setting menu	Setting item	Setting value	*1	*2
Test Mode	Feed Test 1	Start , <input type="checkbox"/> Stop	<input type="checkbox"/>	<input type="checkbox"/>
	Feed Test 2	Start , <input type="checkbox"/> Stop	<input type="checkbox"/>	<input type="checkbox"/>
	Marking Test <small>(only when the stacker unit and the printer unit are installed)</small>	Start , <input type="checkbox"/> Stop	<input type="checkbox"/>	<input type="checkbox"/>
	Printer jet test <small>(only when the stacker unit and the printer unit are installed)</small>	Start	<input type="checkbox"/>	<input type="checkbox"/>

*1 Items displayed when SR-3500 mode or SR-6500 mode is selected as the operating mode.

*2 Items displayed when SR-600 mode or SR-9000 mode is selected as the operating mode.

*3 Maximum number of columns to read differs depending on device sensor pitch.

*4 Data in parenthesis will appear according to options installed in the device.

*5 Factory default values differs depending on device sensor pitch.

1/6 inch:Direct under type 0.2,0.25,0.3 inch:Top-end timing control type 0.3F inch:"FACOM" type

indicates factory default values.

Error displays and countermeasures

1. Errors

(1) Hardware errors [Main body unit]

Error	Explanation	Code	Solution
Memory error 1	Internal memory error 1	A1	None
Memory error 2	Internal memory error 2	A2	None
Hopper drive error	Hopper operating error	A3	None
Download erro	Error while downloading to the main body	A4	None
Sensor type error	<ul style="list-style-type: none"> · Sensor specifications for front surface/back surface reading unit are wrong · Sensor specifications for front surface/back surface reading unit are wrong 	A5	None
Optional error	Optional unit detection error	A6	None
Power supply voltage error	A irregularity is detected in power supply supervisory voltage of control board	A8	None

[Reading unit]

Error	Explanation	Code	Solution
Communication error	Line error occurred between the device and the front side reading unit.	B1	None
	Line error occurred between the device and the back side reading unit.		
Internal com. error	Front side reading unit doesn't replay	B2	None
	Back side reading unit doesn't replay		
Memory error	Front side reading unit memory error	B3	None
	Back side reading unit memory error		
Adjusted value error	Offset value of front side reading sensor exceeds acceptable level.	B4	None
	Offset value of back side reading sensor exceeds acceptable level.		
Download error	Front side reading unit download error	B5	None
	Back side reading unit download error		
Internal error	Front side reading unit internal error	B6	None
	Back side reading unit internal error		
Version error	Front side reading unit version does not correspond to the main body unit.	B7	None
	Back side reading unit version does not correspond to the main body unit.		
	Front and back side reading unit versions do not match.		

[Barcode unit]

Error	Explanation	Code	Solution
Communication error	Line error occurred between the device and the barcode unit.	C1	None
Internal com. error	Barcode unit doesn't reply.	C2	None
Memory error	Barcode unit memory error.	C3	None
Sensor error	Error occurred with barcode sensor.	C4	
Download error	Barcode unit download error.	C5	None
Internal erro	Barcode unit internal error.	C6	None
Version error	Barcode unit version does not correspond to the main body unit.	C7	None

[Printer unit]

Error	Explanation	Code	Solution
Communication error	Line error occurred between the device and the printer unit.	D1	None
Internal com. error	Printer unit doesn't reply.	D2	None
Memory error	Printer unit memory error.	D3	None
Download error	Printer unit download error.	D4	None
Internal erro	Printer unit internal error.	D5	None
Version error	Printer unit version does not correspond to the main body unit.	D6	None

[Stacker unit]

Error	Explanation	Code	Solution
Communication error	Line error occurred between the device and the stacker unit.	E1	None
Internal com. error	Stacker unit doesn't reply.	E2	None
Memory error	Stacker unit memory error.	E3	None
Download error	Stacker unit download error.	E4	None
Internal erro	Stacker unit internal error.	E5	None
Version error	Stacker unit version does not correspond to the main body unit.	E6	None

*** Errors that cannot be resolved**

Turn the power off and turn it back on after a while. If the error cannot be resolved by turning the power off and on, contact the store where you bought.

(2) Transmission errors

Error	Explanation	Code	Solution
Command error	A non-specified command code was received.	F4	Press the (CLEAR) switch (or execute the clear error command).
Parameter error	A non-specified parameter was received.	F5	Press the (CLEAR) switch (or execute the clear error command).
Protocol error	While processing a command, another command was received.	F6	Press the (CLEAR) switch (or execute the clear error command).

* All data that OMR receives while a transmission error occurs will be invalid.

(3) Cover open errors

Error	Explanation	Code	Solution
Cover open	The cover of the main body unit is open	G1	Check if the cover of the main body unit is closed.
Stacker unit cover open	Front door of the stacker unit is open.	G2	Close the front door of the stacker unit.

* When the cover is closed, errors and warnings other than hardware errors will be cancelled.

(4) Jam errors
[Main body unit]

Error	Explanation	Code	Solution
No feed	Paper is not feeding though paper-feeding operation has started.	H1	<ul style="list-style-type: none"> • Reset paper. • Press the (CLEAR) switch (or execute the clear error command).
Jam at paper-feeding detection sensor	A paper jam occurred at the paper-feeding detection sensor.	H2	<ul style="list-style-type: none"> • Remove jammed paper. • Press the (CLEAR) switch (or execute the clear error command).
Jam at reading start detection sensor	A paper jam occurred at the reading start detection sensor.	H3	<ul style="list-style-type: none"> • Remove jammed paper. • Press the (CLEAR) switch (or execute the clear error command).
Jam at main body unit paper discharge detection sensor	A paper jam occurred at the main body unit paper discharge detection sensor.	H4	<ul style="list-style-type: none"> • Remove jammed paper. • Press the (CLEAR) switch (or execute the clear error command).

[Stacker unit]

Error	Explanation	Code	Solution
Jam at printer printing start detection sensor	A paper jam occurred at the printer printing start detection sensor.	I1	<ul style="list-style-type: none"> Remove jammed paper. Press the (CLEAR) switch (or execute the clear error command).
Jam at main paper discharge sensor	A paper jam occurred at the main paper discharge sensor.	I2	<ul style="list-style-type: none"> Remove jammed paper. Press the (CLEAR) switch (or execute the clear error command).
Jam at selected paper discharge sensor	A paper jam occurred at the selected paper discharge sensor.	I3	<ul style="list-style-type: none"> Remove jammed paper. Press the (CLEAR) switch (or execute the clear error command).

2. Warnings

(1) Components

Error	Explanation	Code	Solution
Back side reading unit unconnected	Back surface reading unit is not installed.	P1	<ul style="list-style-type: none"> Check if the back side reading unit is installed. Press the (CLEAR) switch (or execute the clear error command).
Barcode unit unconnected	Barcode unit is not connected.	P2	<ul style="list-style-type: none"> Check if the Barcode unit is installed. Press the (CLEAR) switch (or execute the clear error command).
Printer unit unconnected	<ul style="list-style-type: none"> Printer unit is not installed. Printer cartridge is not installed. 	P3	<ul style="list-style-type: none"> Press the (CLEAR) switch (or execute the clear error command). Set printer control invalid.
Stacker unit unconnected	Stacker unit is not installed.	P4	<ul style="list-style-type: none"> Check if the Stacker unit is installed. Press the (CLEAR) switch (or execute the clear error command).

(2) Paper feeding

Error	Explanation	Code	Solution
Sheet empty	There is no paper in the hopper or the internal units.	Q1	Press the (CLEAR) switch (or execute the clear error command).
Double feed error	Two or more sheets were fed simultaneously.	Q2	Press the (CLEAR) switch (or execute the clear error command).
Left end skew error	Paper was fed crookly.	Q3	Press the (CLEAR) switch (or execute the clear error command).

(3) Operation errors

Error	Explanation	Code	Solution
Hopper stops	Interlock on the side of the paper-feeding roller operated.	R1	<ul style="list-style-type: none"> • Release the interlock switch. • Press the (CLEAR) switch (or execute the clear error command).
Drawing out error	Sheet was pulled out after it was fed.	R2	Press the (CLEAR) switch (or execute the clear error command).
Timeout	A sheet wasn't fed within the set sheet insertion duration.	R3	Press the (CLEAR) switch (or execute the clear error command).
Timing mark error	Only three or fewer timing marks were detected on the front side of the read sheet.	R4	<ul style="list-style-type: none"> • Check the direction of the sheet . • Press the (CLEAR) switch (or execute the clear error command).
	Only three or fewer timing marks were detected on the back side of the read sheet.		
Setting error	When reading front side marks using a timing control type, the next timing mark is detected within the area set by the control multiple number.	R5	<ul style="list-style-type: none"> • Set a reading type and a control multiple number according to paper specifications. • Press the (CLEAR) switch (or execute the clear error command).
	When reading back side marks using a timing control type, the next timing mark is detected within the area set by the control multiple number.		
Black level error	There is light colored stain on the front side reading unit.	S2	Press the (CLEAR) switch (or execute the clear error command).
	There is light colored stain on the back side reading unit.		
Reading start detection sensor soiling error	There is stain on reading start detection sensor.	S3	After cleaning the sensor section turn the power switch on again.

[Main body unit]

Error	Explanation	Code	Solution
Form left in hopper	A sheet remained in the paper feeding detection sensor.	T1	<ul style="list-style-type: none"> Remove the remaining sheet. Press the (CLEAR) switch (or execute the clear error command).
Form left in reading sensor	A sheet remained in the reading start detection sensor.	T2	<ul style="list-style-type: none"> Remove the remaining sheet. Press the (CLEAR) switch (or execute the clear error command).
Form left in end of main body	A sheet remained in the main body unit paper discharge detection sensor.	T3	<ul style="list-style-type: none"> Remove the remaining sheet. Press the (CLEAR) switch (or execute the clear error command).

[Stacker unit]

Error	Explanation	Code	Solution
Form left in printer printing sensor	A sheet remained in the printer printing start detection sensor.	T4	<ul style="list-style-type: none"> Remove the remaining sheet. Press the (CLEAR) switch (or execute the clear error command).
Form left in main paper discharge sensor	A sheet remained in the main paper discharge sensor.	T5	<ul style="list-style-type: none"> Remove the remaining sheet. Press the (CLEAR) switch (or execute the clear error command).
Form left in selected paper discharge sensor	A sheet remained in the selected paper discharge sensor.	T6	<ul style="list-style-type: none"> Remove the remaining sheet. Press the (CLEAR) switch (or execute the clear error command).

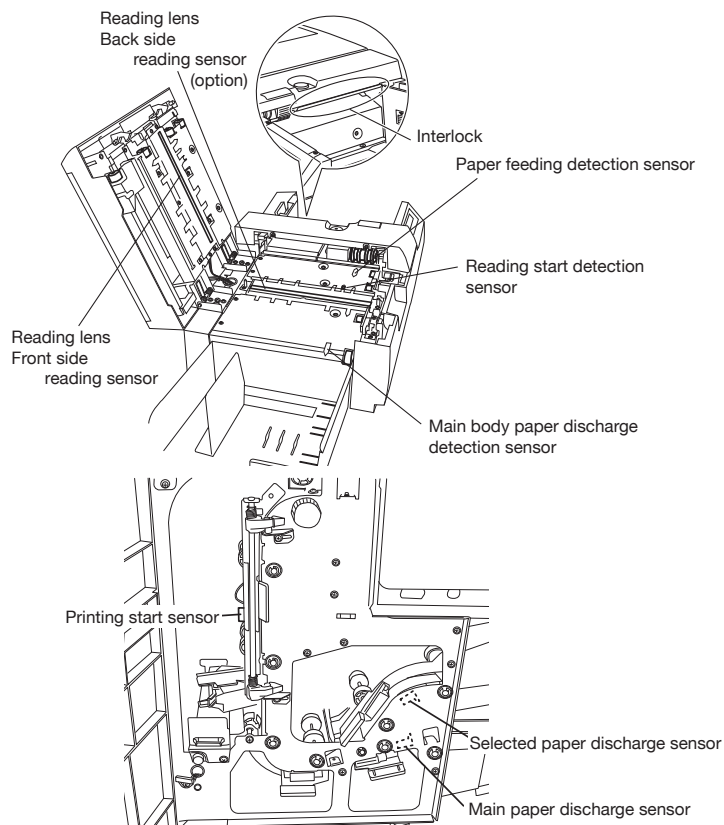

OMR glossary

Column and Row

Mark frames are in columns, timing marks are in rows.

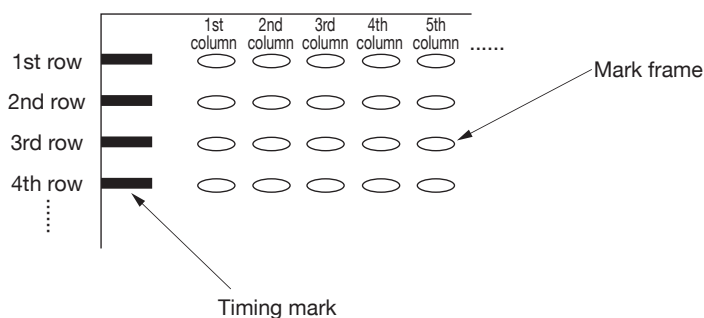

Jam

A paper jam error caused by media when paper is being fed.

There are two kinds of jams: static jams detected when the device is at rest, and operational jams detected while the device is running.

Operational jams include double-feeding jams and no-feeding jams.

Skew

Refers to paper that is slanted against the paper feeding standard.

This function detects whether or not paper is fed straight.

Perforated paper, paper unevenly cut, and curled or bent paper is likely cause skew errors.

Stacker

This refers to the place that sheets that have been read are temporarily stacked.

Stacker volume refers to the number of sheets that can be accommodated.

Example: stacker volume 200 sheets.

Timing control type

If paper has pre-printed timing marks, the scanning area (reading area) of targeted mark frames will be determined by such timing marks.

Timing control type is a method to determine the reading zone based on the timing mark width. Other methods include direct under type, mark to mark type, and FACOM type.

Example: Timing control type to scan three times the timing mark width.
Set multiple numbers using the software controlling OMR.

• Top-end timing control type:

Reads n times the width of a timing mark from the beginning of the timing mark.

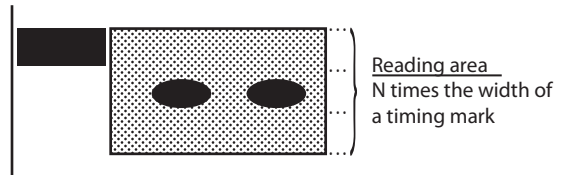

• Bottom-end timing control type:

Reads n times the width of a timing mark from the end of the timing mark.

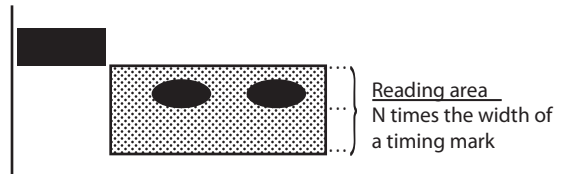

Sensor (for reading) Reading sensor/position sensor

Sensors are photoelectrical elements that transform reflected light. Sometimes sensing refers to both light emission and light reception.

LED wavelength influences dropout color. We use mainly two wavelengths, and the relationships between wavelength, dropout colors, and readable colors are shown in the table below.

Wavelength	Color	Dropout color	Readable color
940nm	Infra red	Colors other than readable colors	Black and blue pigments
660nm	Visible light (red)	Red, orange, pink	Black, blue

Sorter

On a device with two or more stackers, this is a unit that can sort paper based on information such as kind of paper and written marks.

Direct under type

If paper has pre-printed timing marks, the scanning area (reading area) of targeted mark frames will be determined by such timing marks.

Direct under type refers to a method of reading a zone that is the same as the timing mark width.

Other methods include timing control type, mark to mark type, and FACOM type.

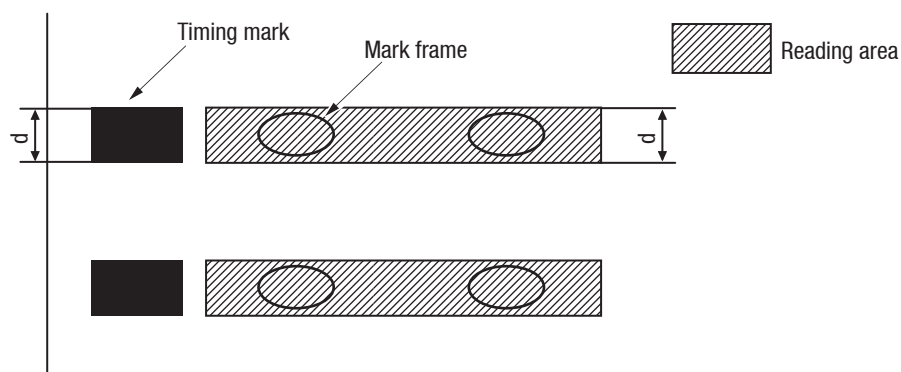

Transmission interface

The hardware connecting a computer and the OMR, in other words the mediating connection. The SR-3500,SR-6500 uses USB or RS-232C interfaces.

Dropout color

Refers to colors pre-printed or written on documents that people can see but that don't appear when read with an image scanner or other devices.

There are "warm colors" and "cold colors" by appearance. Warm colors called orange end, red end, etc. are used as OCR dropout colors, and you need to switch filters in this device for bluish dropout color sheets such as the standard forms used by the Japan Chain Stores Association. Bluish colored lines drop out when they are scanned with copy machines and other devices even if they don't use dropout color ink. OCR paper for fax machines uses "cold color (blue-green)" dropout colors, but there are only a few colors that can be used with most fax machines, because they are different from OCR units.

- (1) Dropout color print darkness is controlled by the PCS value. There are two ways to measure PCS, black backing and white backing, and you should pay attention because they differ depending on the model.
- (2) OCR sheets are generally used for printing character boxes using dropout color inks and printing letters in clear areas.
- (3) Recently, some models have become available that are capable of reading black character boxes, but dropout color printing sheets are often superior in both recognition performance and processing speed.
- (4) Dropout colors are chosen by spectral characteristics and PCS values that are determined by scanner sensor, light source, and filter.

- (5) Colors that can be used as dropout colors differ depending on the model, but with some models, even regular ballpoint pen ink drops out and cannot be used. In such cases, you need special OCR ballpoint pens that are rarely available today. See table below for relationships between wavelengths and colors.

Peak sensitivity wavelength	Color	Remarks
740(nm)	Sepia	Abundant dropout colors Some ballpoint pens cannot be used.
	Magenta	
	Purple	
	Brown	
	Bluish tones Greenish tones	
660	Rose	For red end colors only, rose aniline, purplish red, deep red Regular ballpoint pens can be used.
	Pink	
	Red	
	Orange	
570	Yellow	As in fax scanners, it's difficult to see with human eyes → should be avoided. Regular ballpoint pens can be used.
530	Blue	Regular ballpoint pens can be used for blue-end colors only. Green
	Green	

- a) It is important to control the PCS value to print dropout colors. (You need to choose a printer equipped with devices that can measure PCS values.)
- b) If you want to use an abundance of colors, we recommend printing in ink other than dropout colors as a “black frame sheet.”

No feed

Refers to paper doesn't get fed during paper feeding operations. If such an error occurs, the device assesses it as a paper feeding error, and notifies user of the error.

PCS (printed contrast signal)

Refers to the reflectance ratio (contrast) of printed marks, symbols, and letters as opposed to reflectance of non-printed areas. The calculation formula is as follows.

$$PCS = \frac{\text{White reflectance} - \text{black reflectance}}{\text{White reflectance}}$$

When reflectance of areas with no printing is 70%, and reflectance of printed marks, symbols, and letters is 10%, the PCS will be 0.857.

Writing implements

Readable marks and unreadable marks depend on the writing instruments used. This can also differ according to the light source that the reading sensor uses.

Relationships between sensors used for OMR (light source) and writing implements

Light source wavelength	Color tone	Readable mark colors and writing implement	Unreadable mark colors and writing implement
940nm (standard)	Infra red	Color: black (pigment) Writing implement: pencil	Color: other than black Writing implement: other than pencil
660nm (*Option)	Visible light (red)	Color: black, brown, blue, green, purple Writing implement: pencil, fountain pen, water/oil base ballpoint pen, water/oil base marker	Color: red, orange, yellow Writing implement: items in above colors

“FACOM” type

If paper has pre-printed timing marks, the scanning area (reading area) of targeted mark frames will be determined by such timing marks.

FACOM type refers to a method of determining the reading zone based on a pair of start timing and stop timing marks. Other methods include timing control type, direct under type, and mark to mark type.

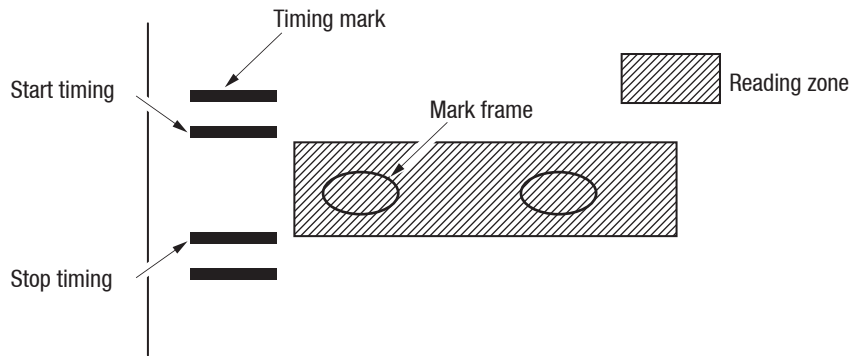

Hopper

A place to put sheets to be processed for marking and compilation.

Mark to mark type

If paper has pre-printed timing marks, the scanning area (reading area) of targeted mark frames will be determined by such timing marks.

Mark to mark type is a method to read zones between two timing marks. Therefore, the number of timing marks in mark to mark type forms is always an even number. Other methods include timing control type, direct under type, and FACOM type.

- Mark to mark type
(without top-end margin reading):
The reading zone is the area between timing marks.

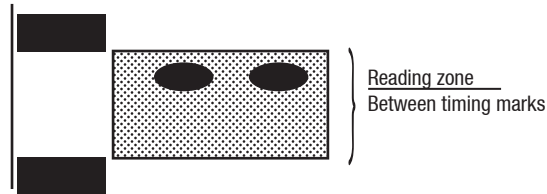

- Mark to mark type
(with top-end margin reading):
The reading zones are the front margin of the form as the first row, and between timing marks as the second and subsequent rows.

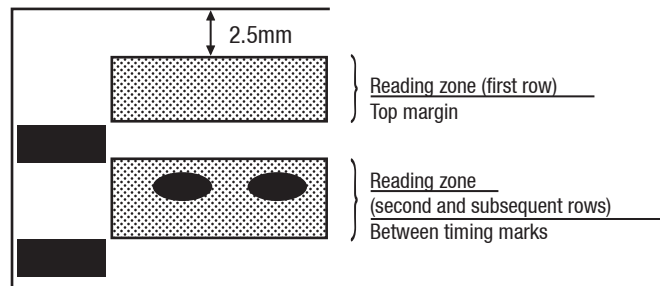

Double-feeding

Refers to two or more sheets being fed at the same time during paper feeding operation. If such an error occurs, the device assesses it as a paper feeding error, and notifies users of the error.

Form

- (1) OCR paper (optical character recognition paper)
Paper for data processing to optically read letters and symbols. It should not be dusty, and it should be smooth, stiff, abrasion resistant, and antistatic.
JIS X 9004 (printing specifications for optical character recognition)
- (2) Quality paper
Paper made from pure chemical pulp. Used for printing and writing.
JIS P 3101 (printing paper) JIS P 3201 (writing paper)
- (3) Paper weight
Paper is categorized by weight.

Appendix

■ Sheet creation reference

You can use paper that you make yourself with this device in addition to the optional paper that we offer. If you make your own paper, follow the specifications below.

- (1) Sheet size
Height 110-335.6mm Width 63.5-228.6mm
Do not cut or round the corners on the reference side (timing mark side).
(See P.iv)

- (2) Weight and thickness

g/m2 (grams per sheet)	84 - 157
mm (thickness)	0.1 - 0.19

- (3) Paper quality
OCR paper, quality paper, or recycled OCR paper.
- (4) Printing ink (printing surrounding mark fields)
When the wavelength of the OMR reading sensor light source is 940nm, use spectrum band B900 to measure the PCS and use ink at PCS 0.15 or less. Print timing marks in ink at PCS 0.85 or higher.
When the wavelength of the OMR reading sensor light source is 660nm, use spectrum band B680 to measure the PCS and use ink at PCS 0.15 or lower. Print timing marks in ink at PCS 0.85 or higher.
- (5) Printing position accuracy
- | | |
|------------------|---|
| Parallelism | Adjust printing parallelism for timing marks and data marks 0.2mm or less based on the cutting edge of the timing mark side. |
| Perpendicularity | Adjust printing perpendicularity for timing marks and data marks 0.2mm or less based on the cutting edge of the timing mark side. |
| Other | Adjust to ± 0.2 mm or less of specified measurements unless otherwise specified. |
- (6) Prohibited printing zones
Do not print between timing marks, or between the top-end (bottom-end) timing mark and the top edge (bottom edge) of the mark sheet.
Top-end margin*: 9mm or more from the top edge to the first timing mark.
Bottom-end margin: 9mm or more from the last timing mark to the bottom edge.
Side margin: 4mm or more on the opposite side of the sheet's standard edge.
*For IBM card size, top end margin is 5mm or more, bottom- end margin is 6mm or more
- (7) Direction of paper grain
Feed paper in the direction of its grain to eliminate curling.



(8) Clear zones

Do not print in colors other than dropout colors 0.8mm around reading zones and 0.8mm from timing mark longitudinal ends.

Reading zone:

The vertical direction of the data mark standard position is the height set by command, and the horizontal width refers to the area of the data mark frame width.

Dropout colors:

Dropout colors refers to colors that are already printed or written on a document that can be seen by human eyes but cannot be recognized by a reading sensor.

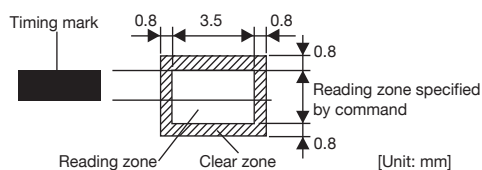

(9) Black ink printing

Descriptions, etc. can be printed in areas except print prohibition zones and clear zones. However, never print anything at PCS 0.15 or more other than timing marks in timing mark columns from the top edge of sheet to the bottom edge on either side of the paper.

(10) Printing on back surface

You can print on the back surface except in print prohibition zones. However, do not print at PCS exceeding 0.15 in clear zones on the front surface in case of bleeding through from the back.

(11) ID mark

Set an ID mark for identification as necessary.

Size: 1.0mm or longer x 3mm or longer.

Reading darkness: PCS 0.8 or higher

Angle: ± 5 degree or less (against the line perpendicular to the standard side)

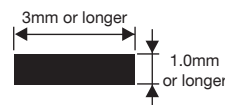

(12) Mark frame

Rectangles, ovals, and circle shapes have been conventionally used for mark frames.

Frame size should be smaller than the reading zone in various reading methods (direct under type, timing control type, mark to mark type, and FACOM type).

Recommended sizes are as follows.

Rectangles: Vertical 0.8-1.5mm Horizontal 3-3.5mm

Ovals: Vertical 1.5-2.5mm Horizontal 3-4.3mm

Circles: O 3.0-3.5mm

*Maximum horizontal length differs depending on sensor pitch.

Adjust horizontal length = (sensor pitch - 0.7mm) or less.

*Printing color: print at PCS 0.15 or less in dropout color.

(13) Paper dimensions
[Direct under type sheet]

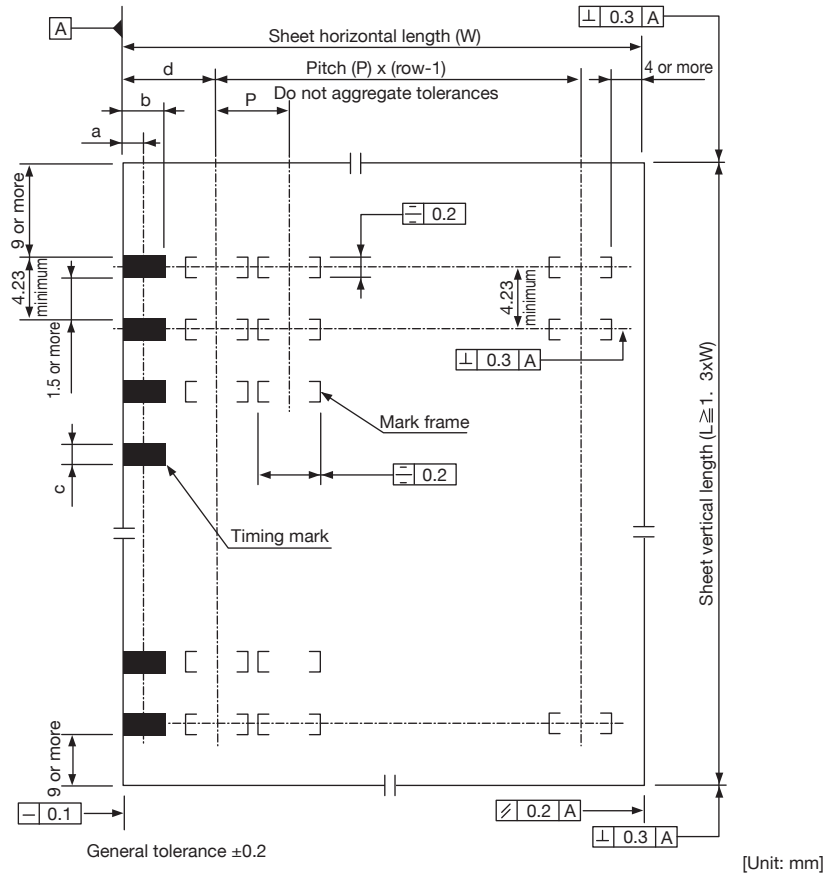

	1/6	0.2	0.25	0.3	Maximum number of columns				Maximum number of rows
					1/6	0.2	0.25	0.3	
IBM*	82.55	187.3	16	13	12	9	40		
Postcard	100	148	20	17	14	11	31		
A5	148	210	31	26	22	17	46		
B5	182	257	39	33	27	22	57		
A4	210	297	46	38	32	25	66		
8.5"	216	279	47	40	33	26	62		
9"	228.6	355.6	48	40	33	27	80		

	1/6	0.2	0.25	0.3
a	6.99	1.91	1.78	2.5
b	3.81	3.81	3.56	5.00
c	1.27	1.27	1.27	1.27
d	11.43	11.75	6.35	14.50

- Note 1) Timing mark width: maximum width of c is 12mm.
- Note 2) Maximum number of rows indicates the number of timing marks.
- Note 3) Printing specifications for IBM card size are described on the next page.

[Direct under type card (0.25" IBM card size)]

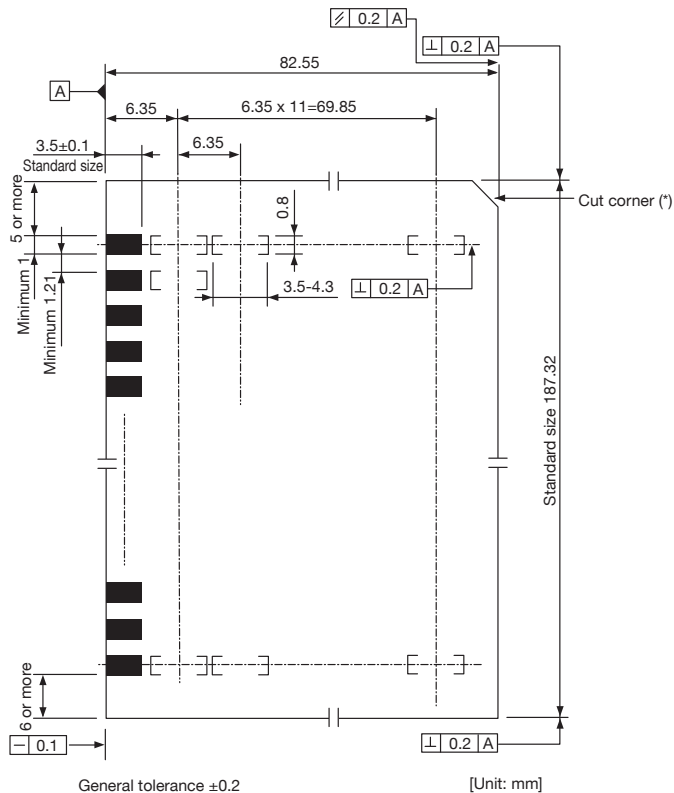

* Cut corners and round corners

They help you to easily check if paper is placed in the right direction, and help you to manage paper and keep it orderly. Cut paper corners straight or rounded according to the specifications shown below.

Straight cut corners: standard 6mm or less.
Chamfer angle 45°

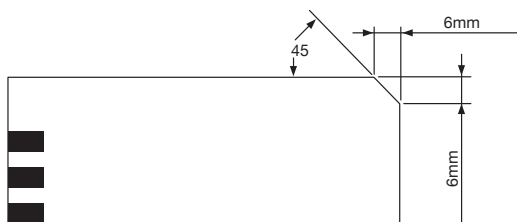

Round corners: R 6mm

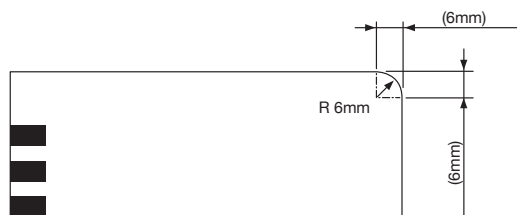

[Timing control type sheet]

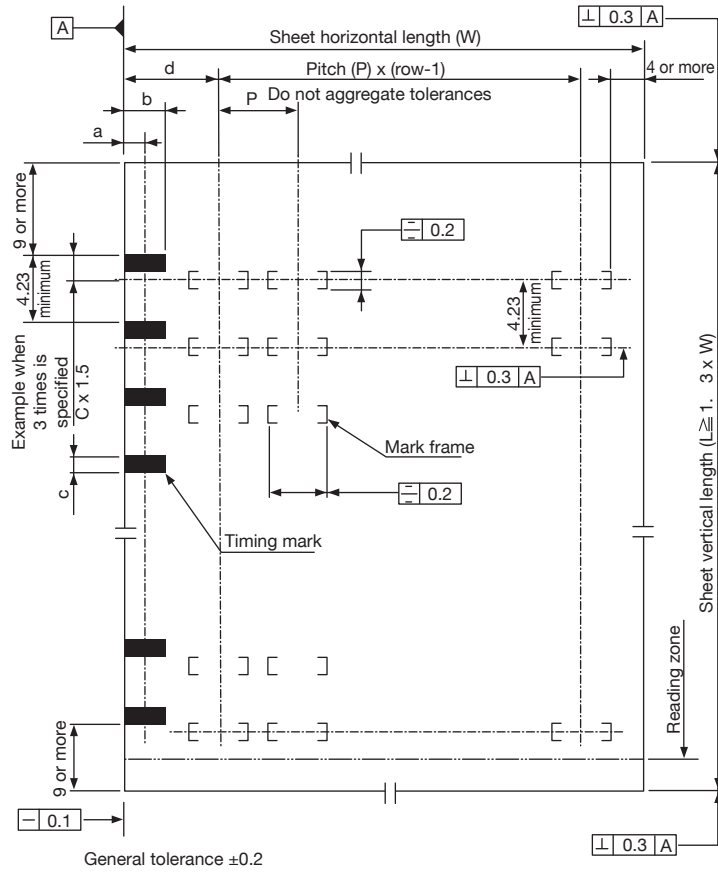

[Unit: mm]

	1/6	0.2	0.25	0.3
a	6.99	1.91	1.78	2.5
b	3.81	3.81	3.56	5.00
c	0.89	0.89	0.89	0.89
d	11.43	11.75	6.35	14.50

Size	W x L (mm)	Maximum number of columns				Maximum number of rows
		1/6	0.2	0.25	0.3	
IBM*	82.55 x 187.3	16	13	12	9	40
Postcard	100 x 148	20	17	14	11	31
A5	148 x 210	31	26	22	17	46
B5	182 x 257	39	33	27	22	57
A4	210 x 297	46	38	32	25	66
8.5"	216 x 279	47	40	33	26	62
9"	228.6 x 355.6	48	40	33	27	80

- Note 1) Timing mark width: maximum width of c is 12mm.
- Note 2) Maximum number of rows indicates the number of timing marks.
- Note 3) Set magnification values in order for the gap to be possible 1.4 mm or more from the top-end of next timing mark.

[Mark to mark type sheet]

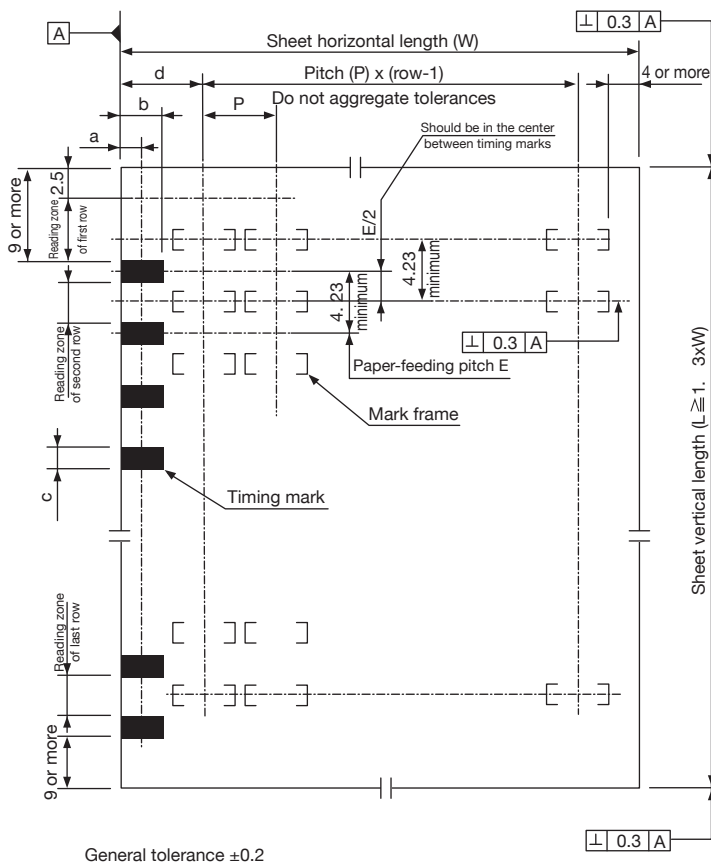

[Unit: mm]

	1/6	0.2	0.25	0.3	Size	W x L (mm)	Maximum number of columns				Maximum number of rows
							1/6	0.2	0.25	0.3	
a	6.99	1.91	1.78	2.5	IBM*	82.55 x 187.3	16	13	12	9	40
b	3.81	3.81	3.56	5.00	Postcard	100 x 148	20	17	14	11	31
c	1.0	1.0	1.0	1.0	A5	148 x 210	31	26	22	17	46
d	11.43	11.75	6.35	14.50	B5	182 x 257	39	33	27	22	57
					A4	210 x 297	46	38	32	25	66
					8.5"	216 x 279	47	40	33	26	62
					9"	228.6 x 355.6	48	40	33	27	80

- Note 1) Timing mark width: maximum width of c is 12mm.
- Note 2) Maximum number of rows indicates the number of timing marks.
- Note 3) Printing specifications for IBM card size are described on the next page.

[Mark to mark type card (0.25" IBM card size)]

